



# MINECRAFT

21242





### **Get excited about our new packaging!**

We're switching from plastic to paper-based packaging. That's why you might find a mix of paper and plastic in our boxes!

### **Nos nouveaux emballages vous emballeront !**

Nous passons des emballages en plastique aux emballages à base de papier. C'est pourquoi vous pourriez trouver un mélange de papier et de plastique dans nos boîtes !

### **¡Te presentamos nuestros nuevos empaques!**

Estamos sustituyendo las bolsas de plástico por bolsas con base de papel. ¡Por eso, puedes encontrar una mezcla de papel y de plástico en nuestras cajas!

**[LEGO.com/sustainable-packaging](https://www.lego.com/sustainable-packaging)**

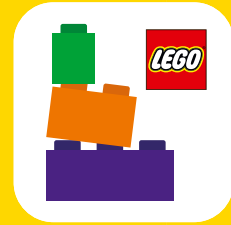

# BUILDER



Apple and the Apple logo are trademarks of Apple Inc., registered in the U.S. and other countries and regions. App Store is a service mark of Apple Inc. Google Play and the Google Play logo are trademarks of Google LLC. Tencent and the Tencent logo are trademarks of Tencent Inc.

Q [LEGO.com/devicecheck](https://www.lego.com/devicecheck)

**EN** Ask parents' permission before going online | **DE** Eltern um Erlaubnis bitten, bevor du online gehst | **FR** Demande l'autorisation d'un parent avant d'aller en ligne | **IT** Chiedi il permesso ai tuoi genitori prima di andare online | **ES** Pídeles permiso a tus papás antes de conectarte a Internet | **PT** Peça autorização aos pais antes de acederes online | **JA** オンラインになる前にほご者の方のきよかをもらおう | **ZH** 上网前应先征得父母的同意 | **KO** 온라인 접속 전에 보호자 동의가 필요합니다 | **RU** Спроси разрешения у родителей, прежде чем заходить в интернет | **PL** Poproś rodziców o zgodę, zanim wejdiesz do Internetu | **CS** Než půjdeš na internet, požádej rodiče o svolení | **SK** Skôr než pôjdeš na internet, vypýtaj si povolenie od rodičov | **HU** Kérj szülői engedélyt, mielőtt online csatlakoznál! | **RO** Cere permisiunea părinților înainte de a te conecta online | **BG** Поискайте разрешение от родител, преди да влезете онлайн | **LV** Pirms došanās tiešsaistē palūdz atļauju vecākiem | **ET** Enne Interneti kasutamist küsi vanematelt luba | **LT** Prieš prisijungdami prie interneto, atsiklauskite tėvų

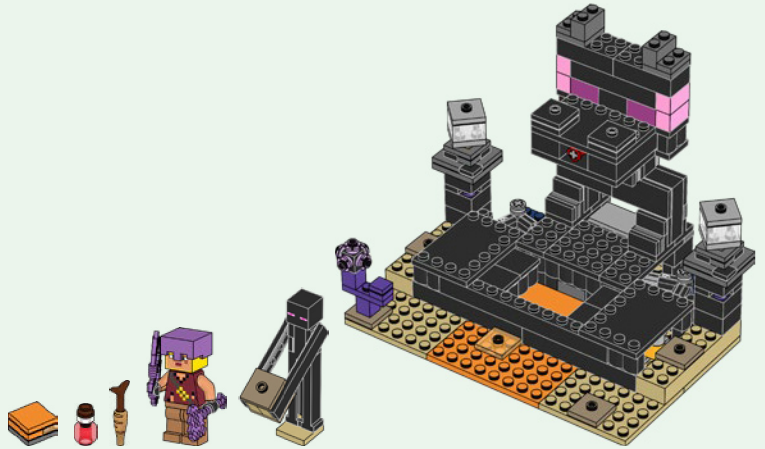
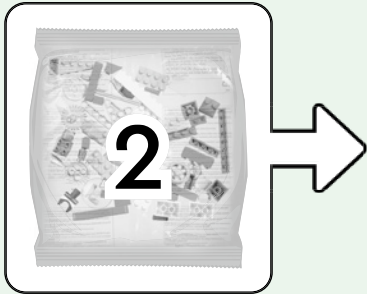
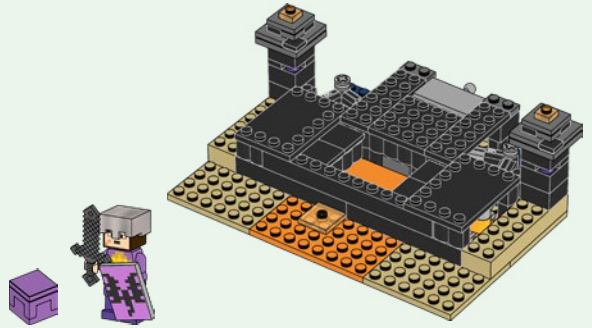
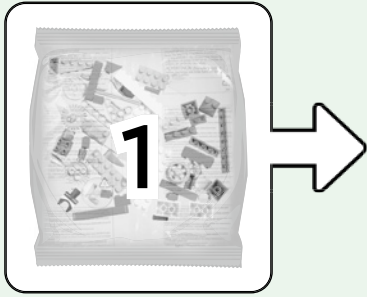

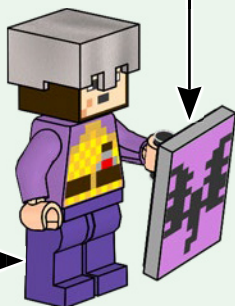
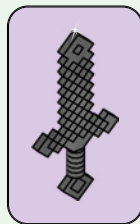
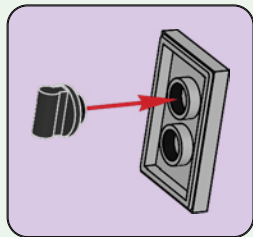
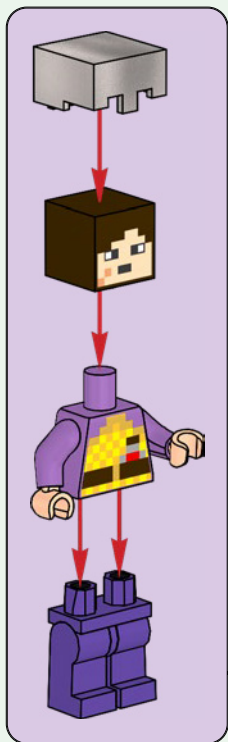

1

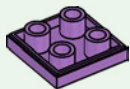

2

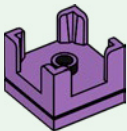

3

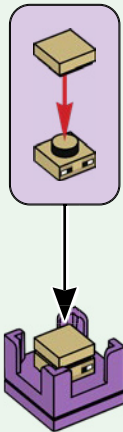

4

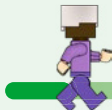
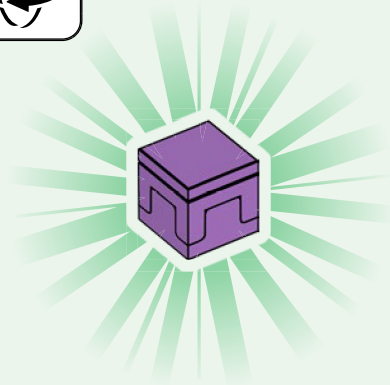
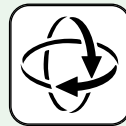
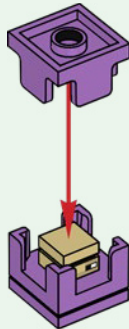

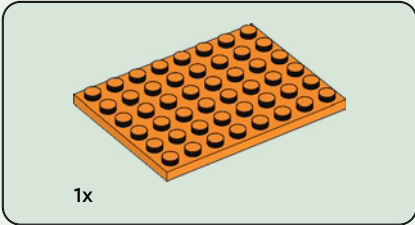
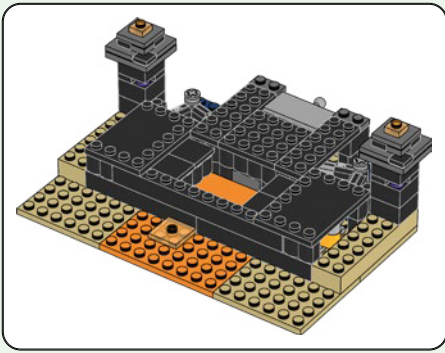

1

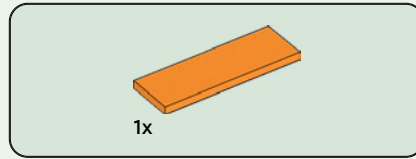
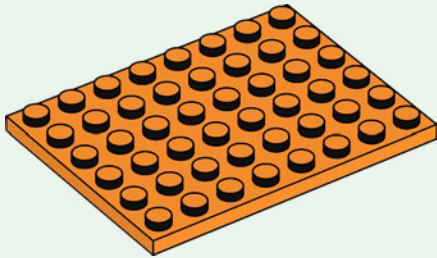

2

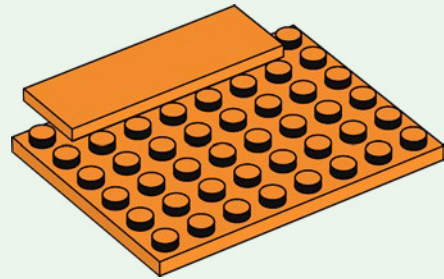

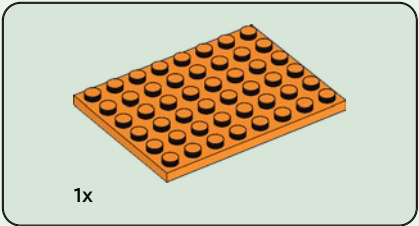

3

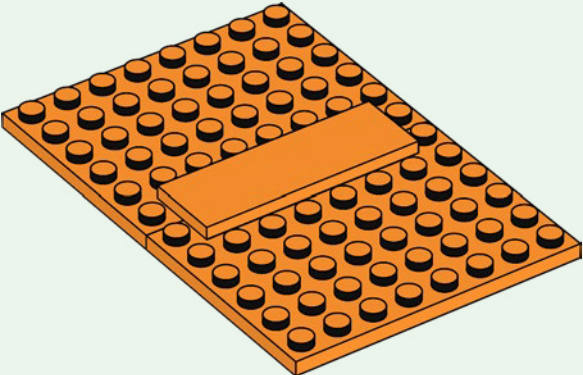



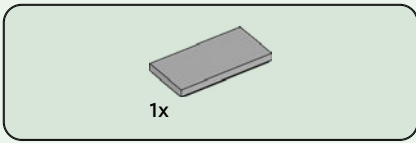

4

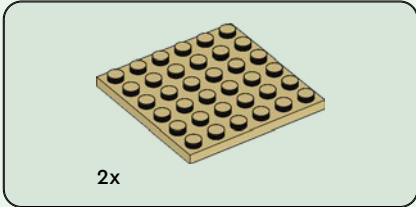
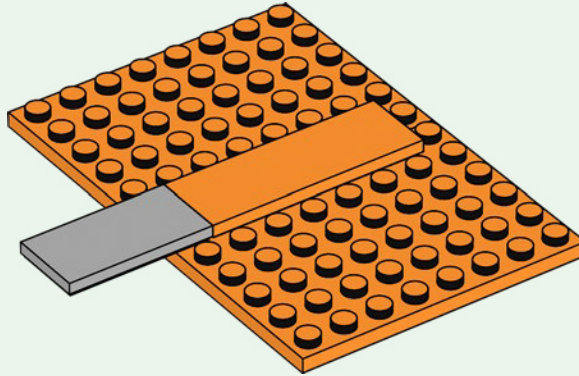

5

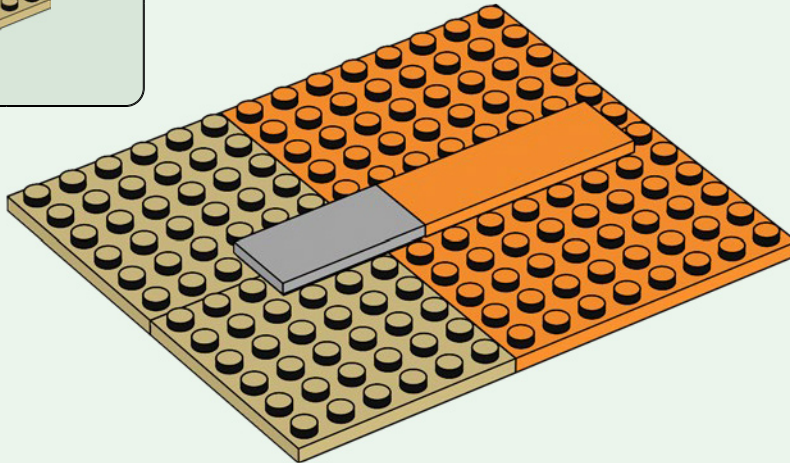

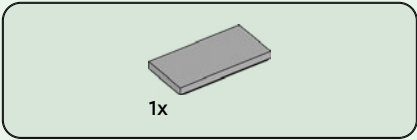

6

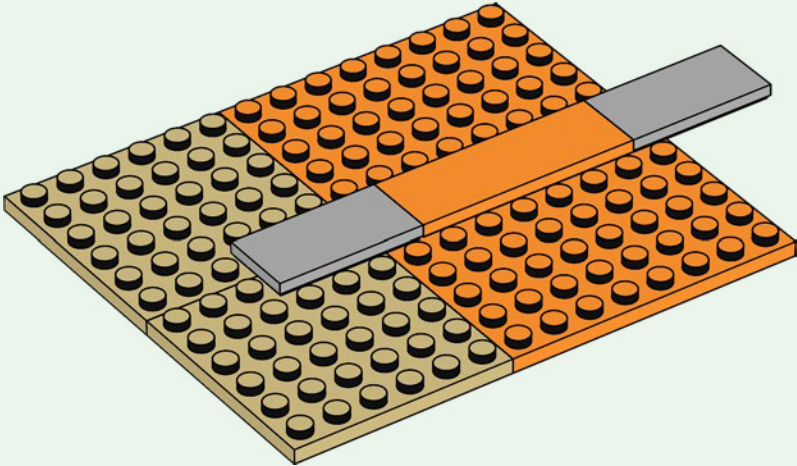

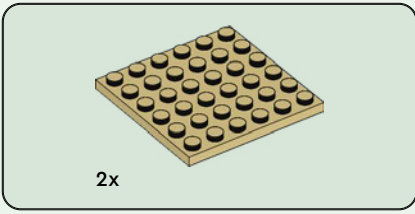

7

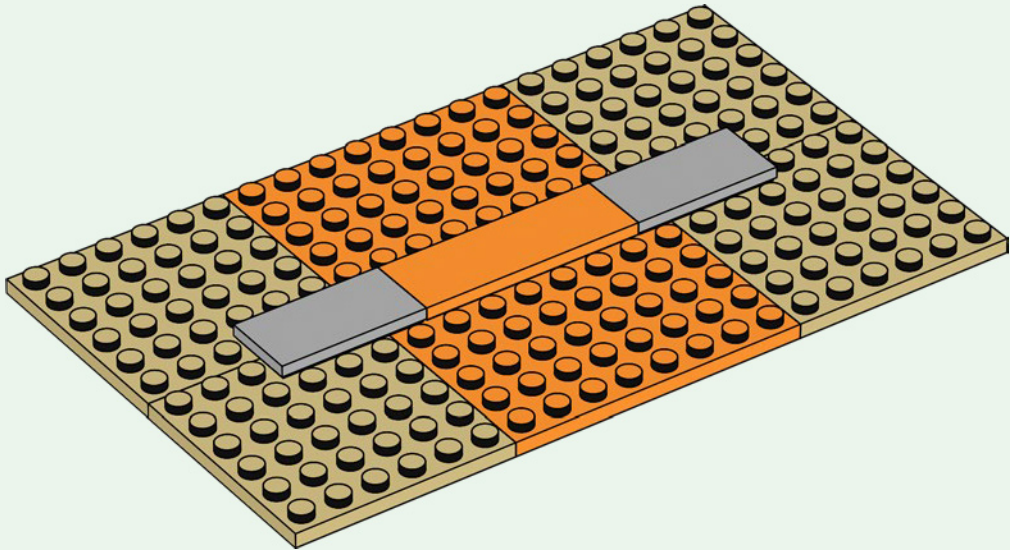

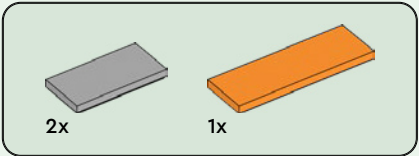

8

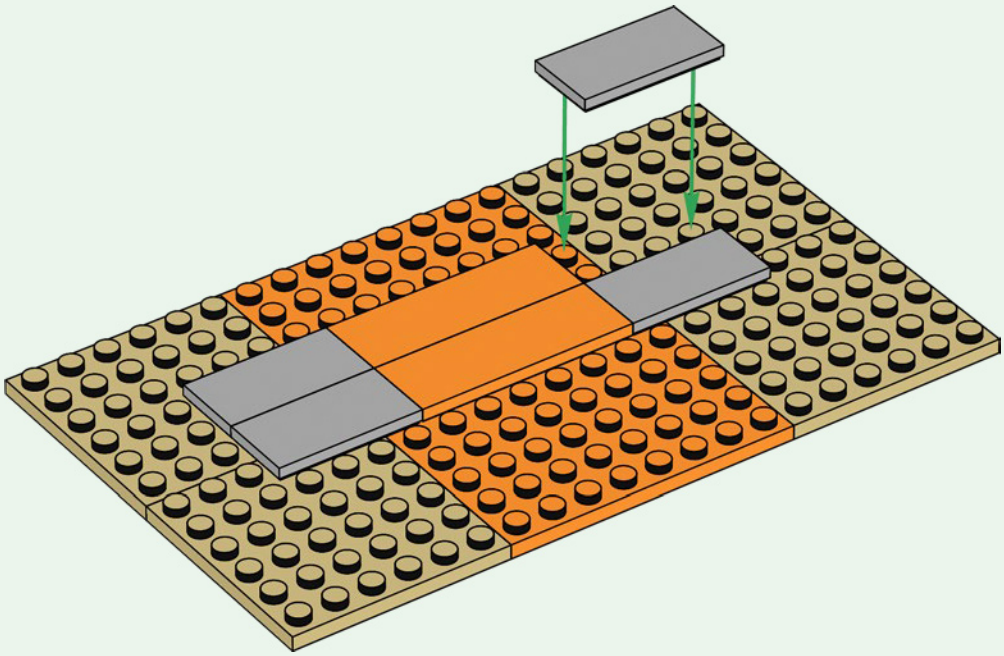

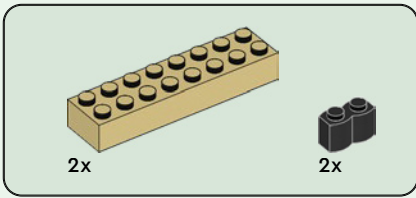

9

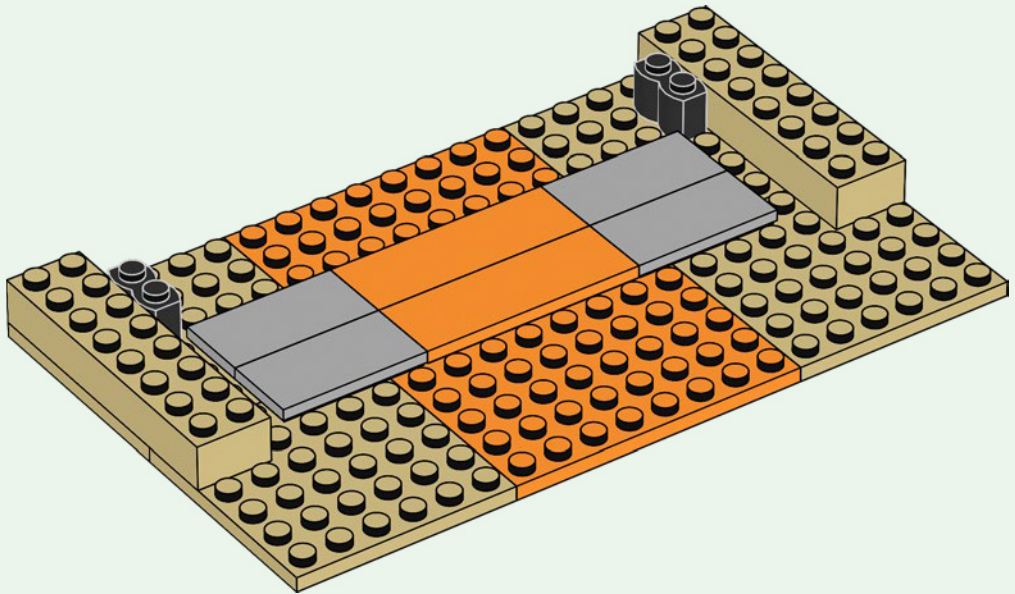

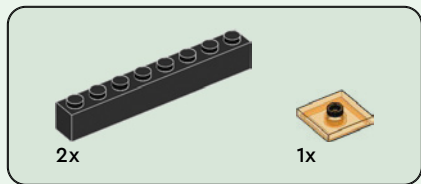

10

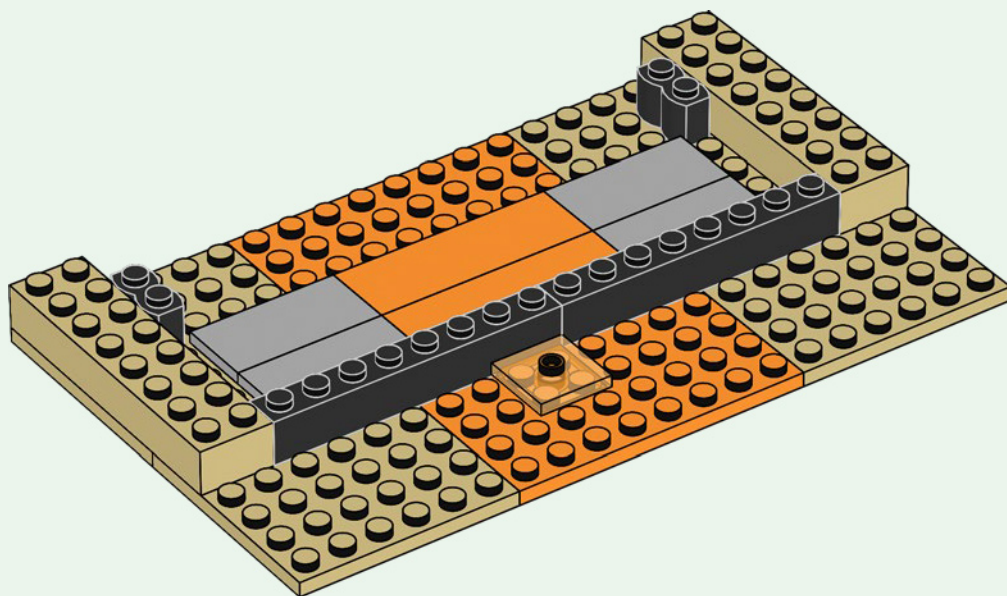

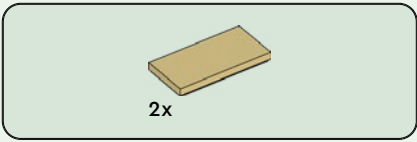

11

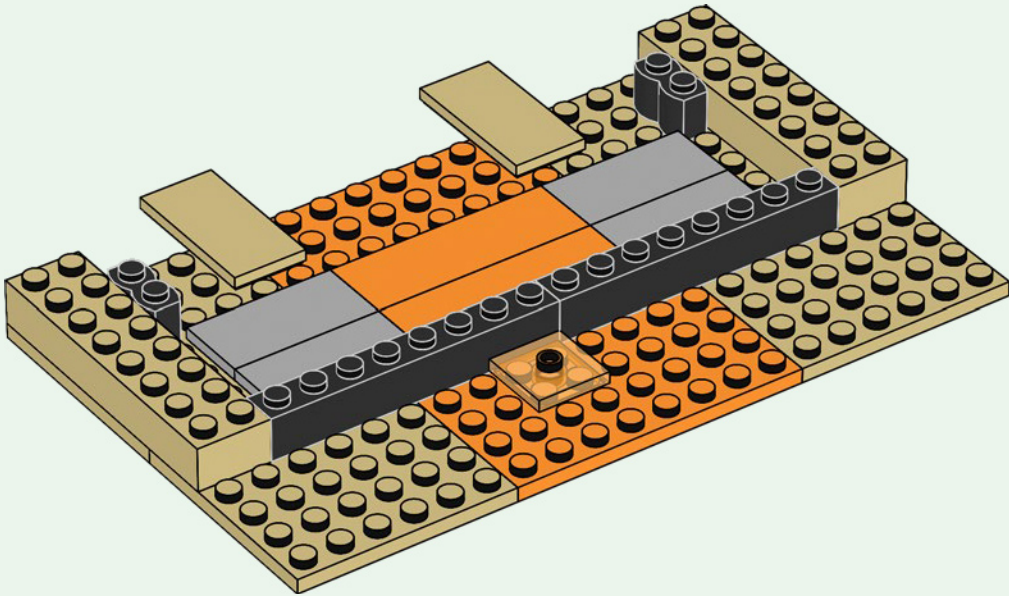

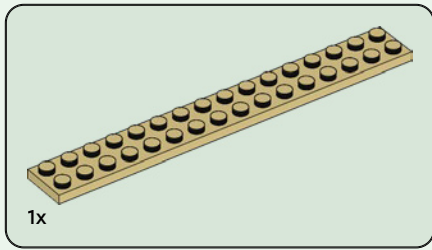

12

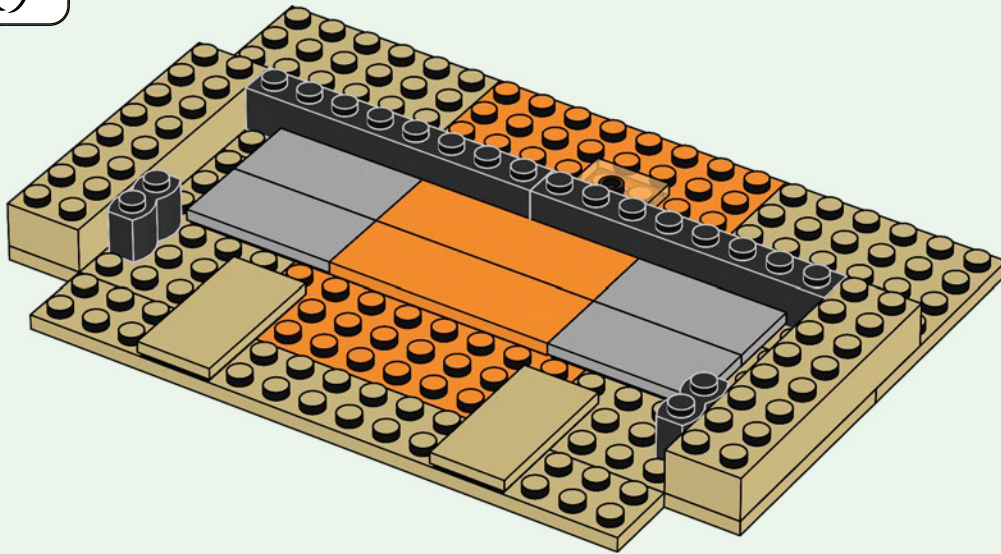



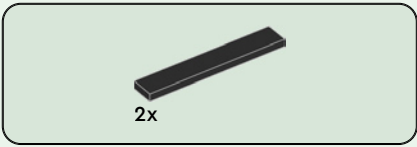

13

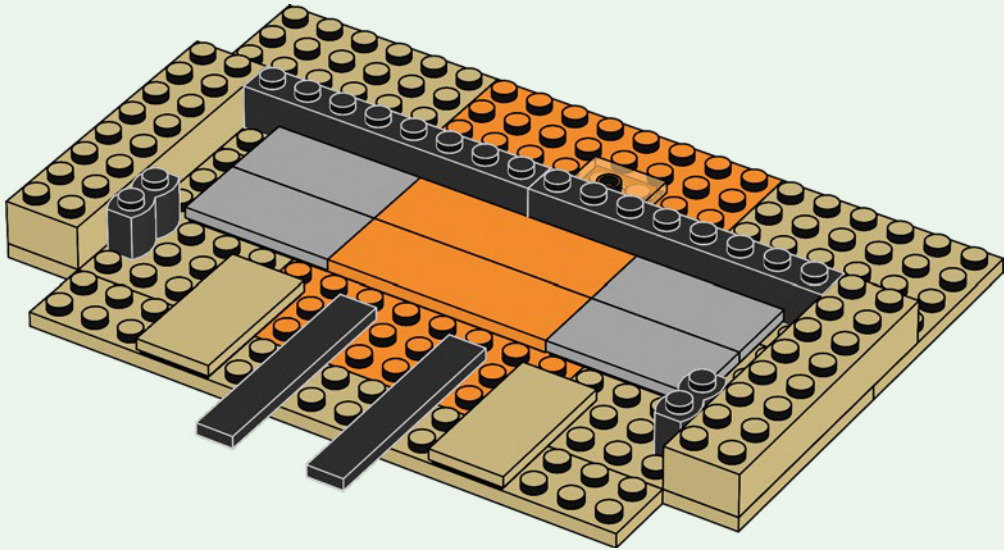

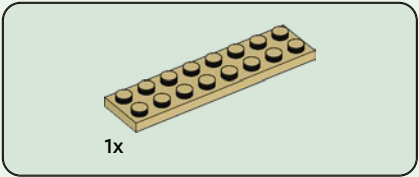

14

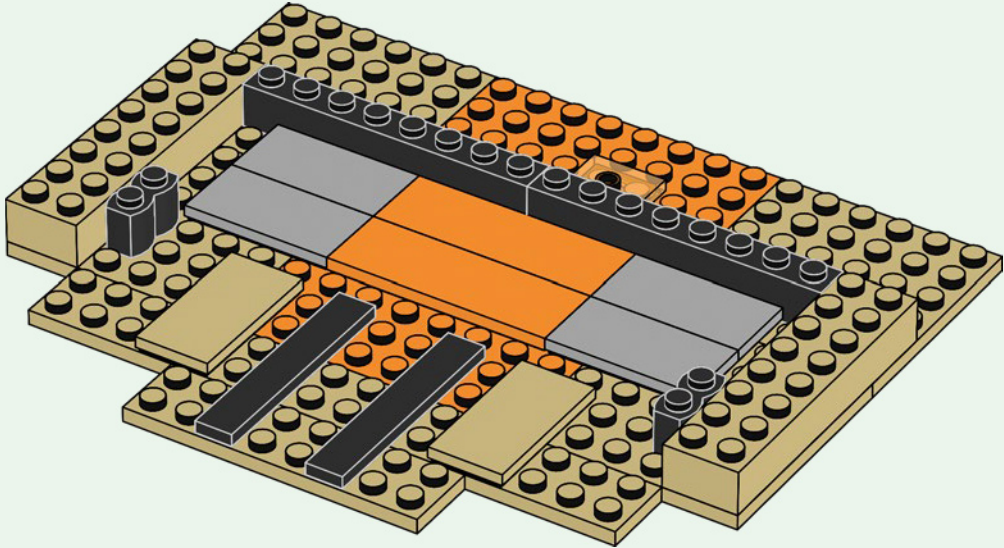



15

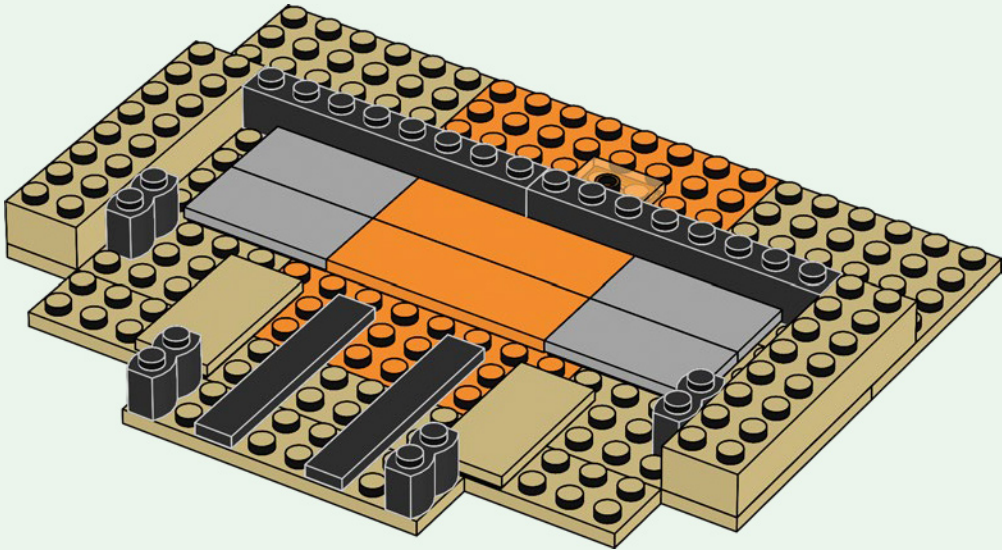



2x

16

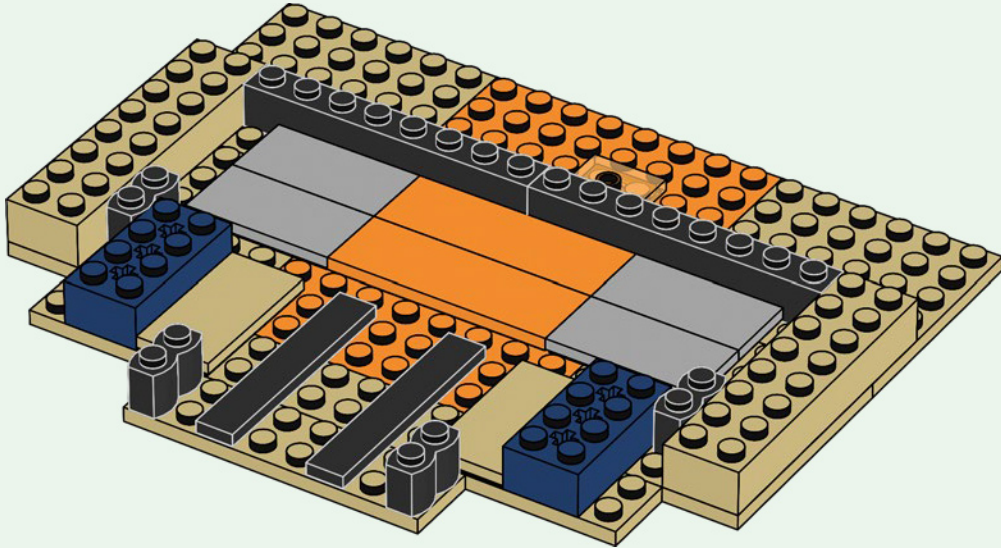



1x

17

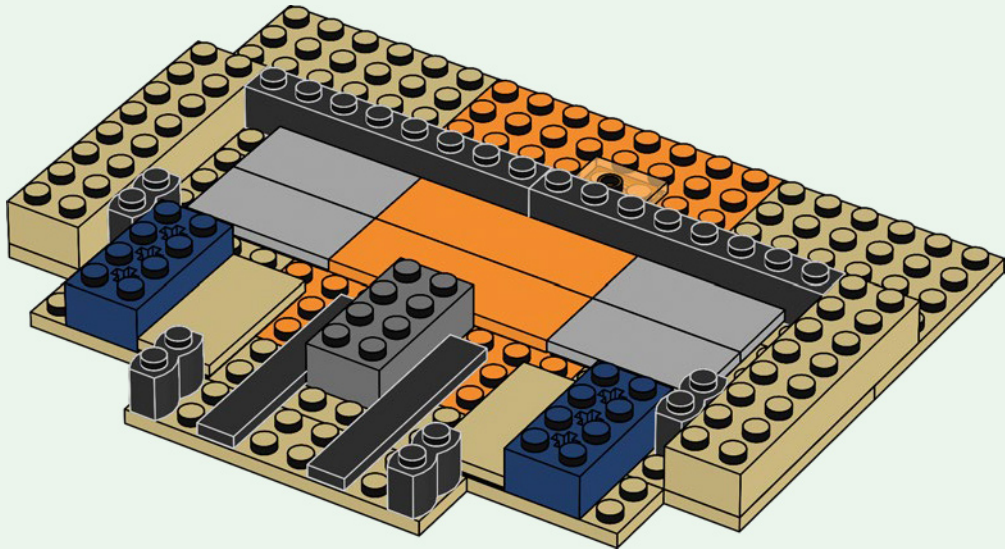



2x

18

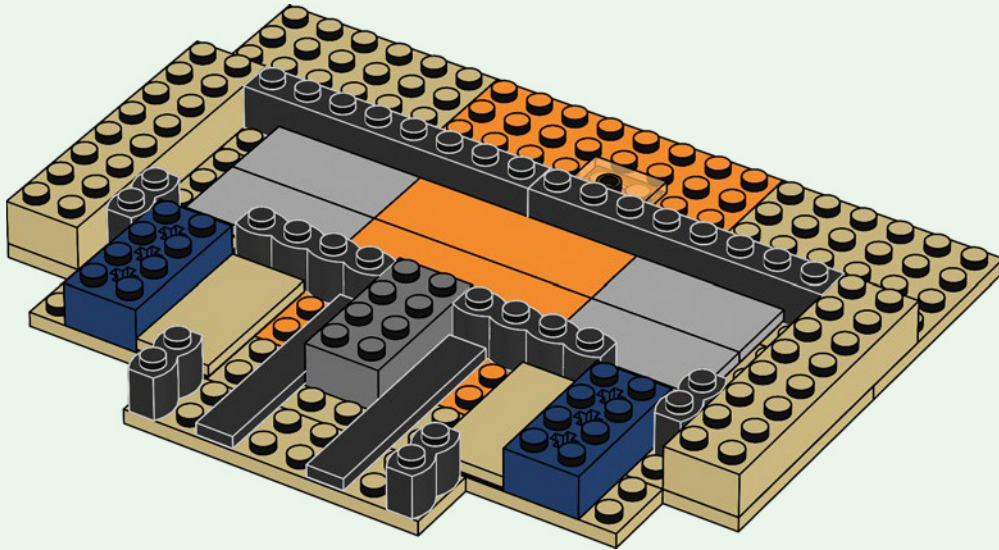



1x

19

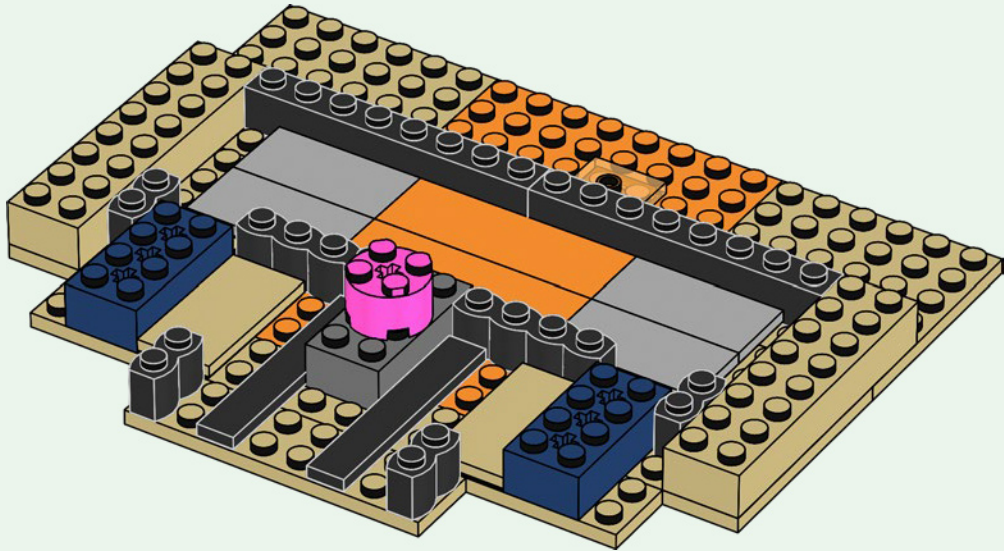

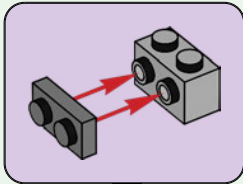
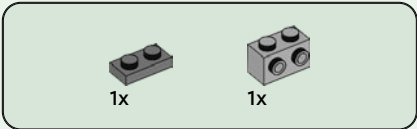

20

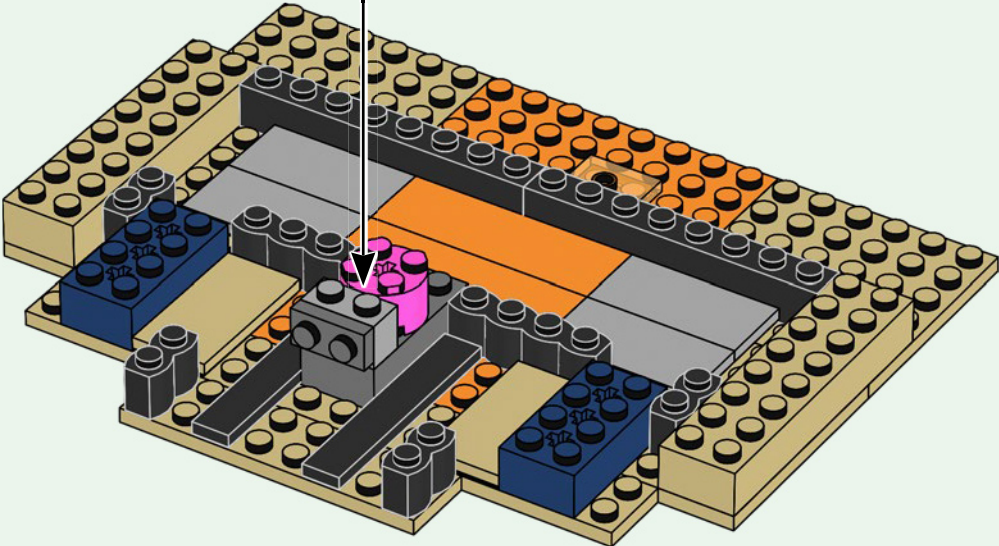



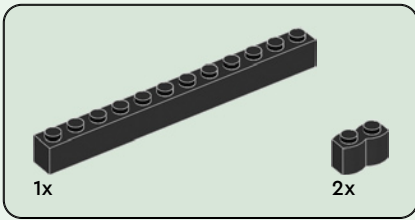

21

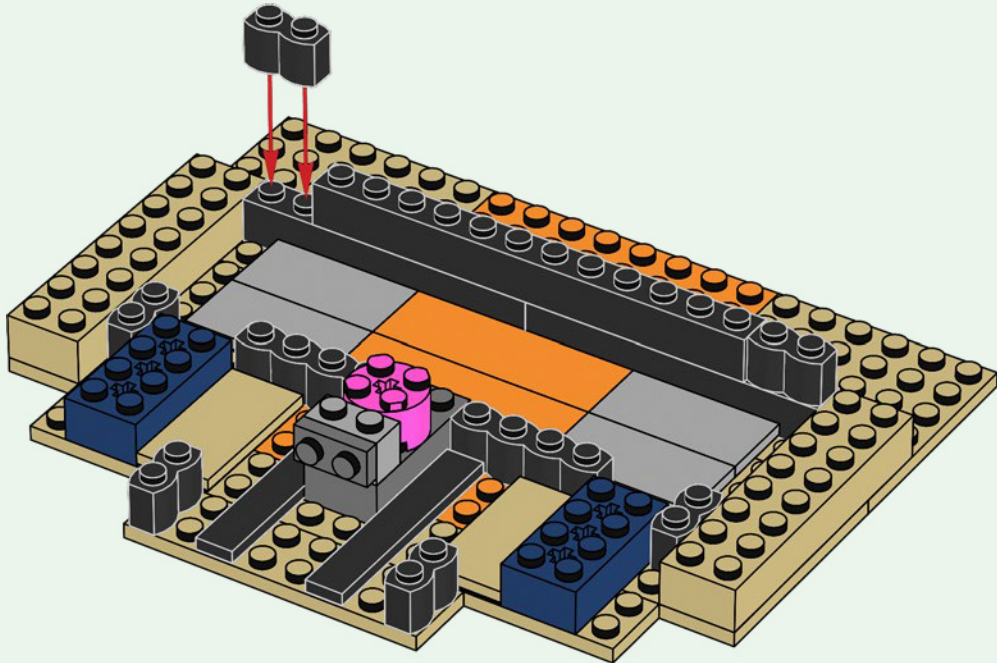

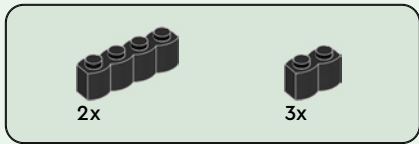

# 22

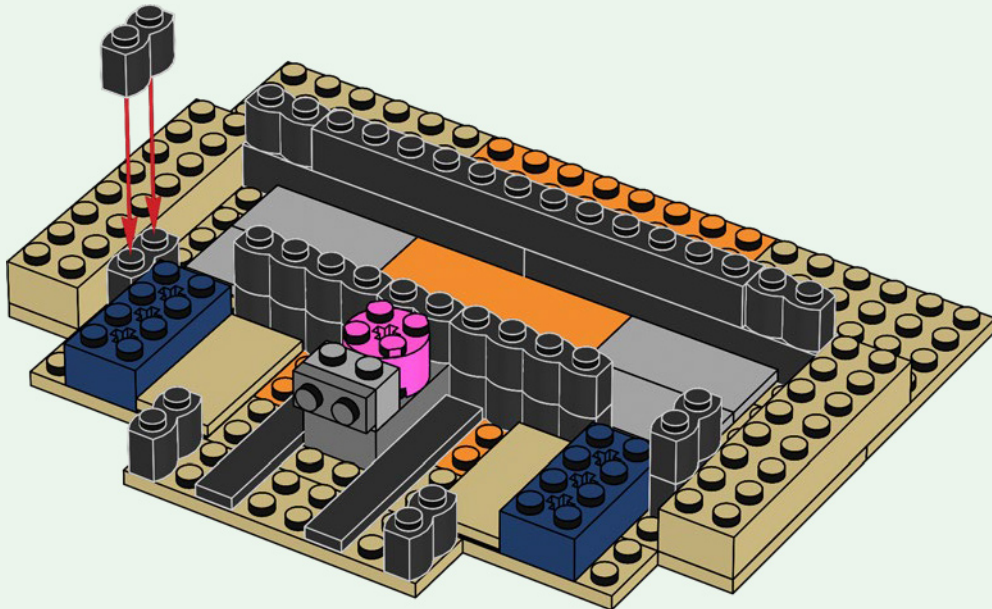

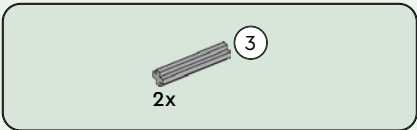

23

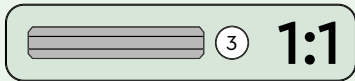
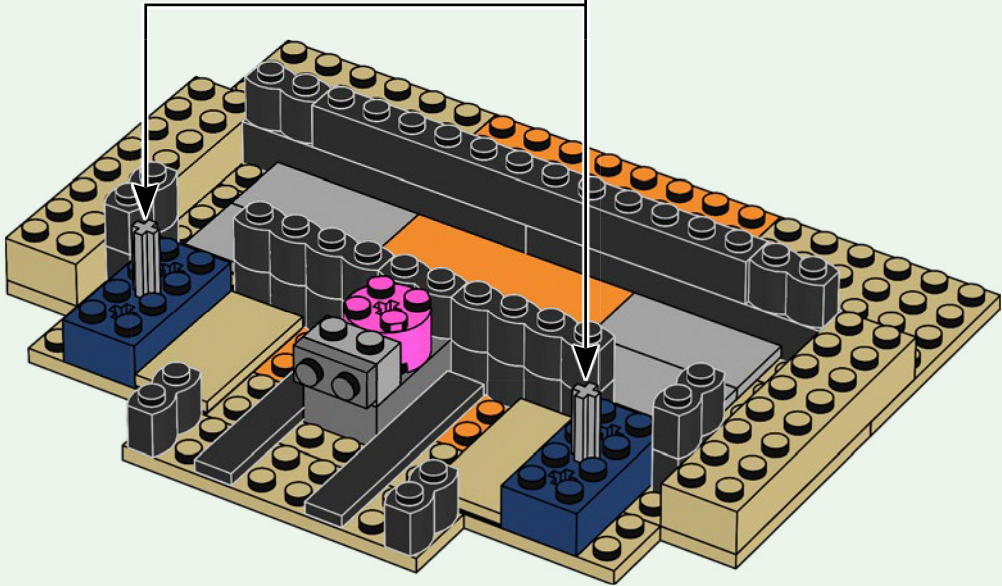
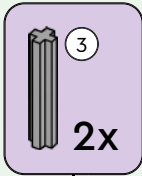

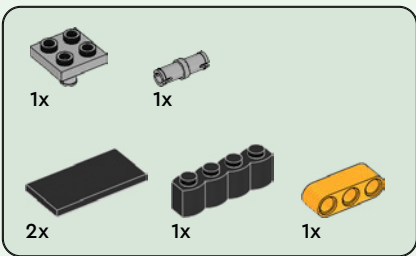

24

1

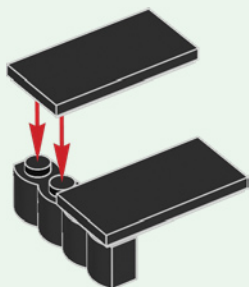

2

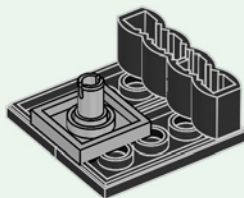

3

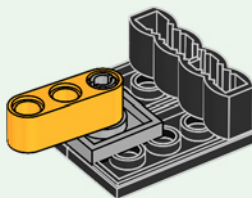

4

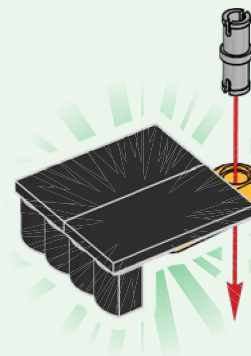

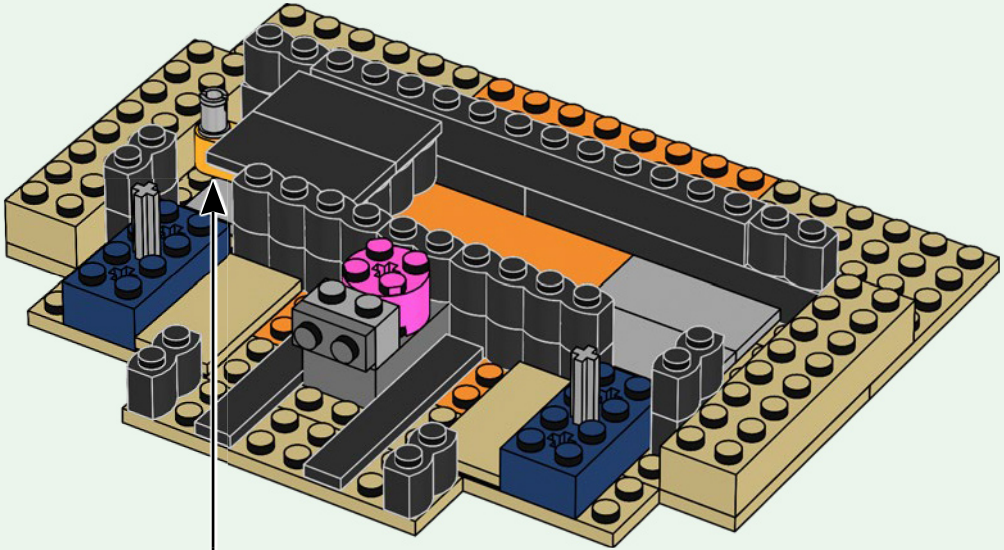

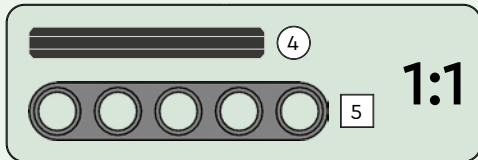
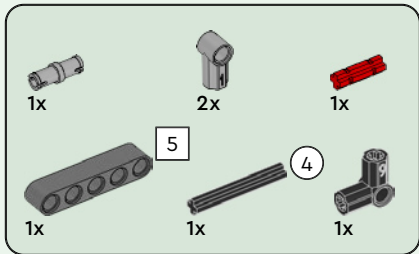

25

1

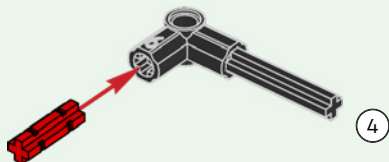

2

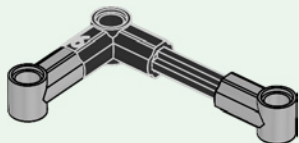

3

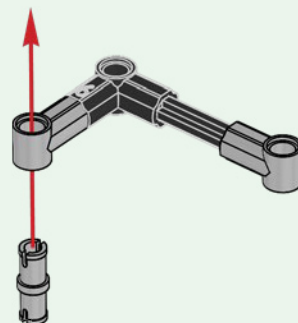

4

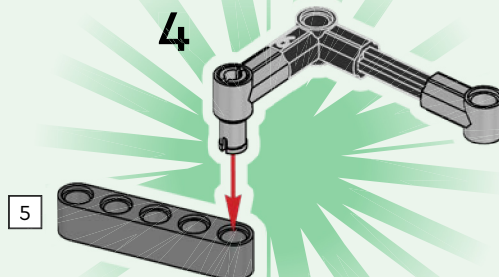

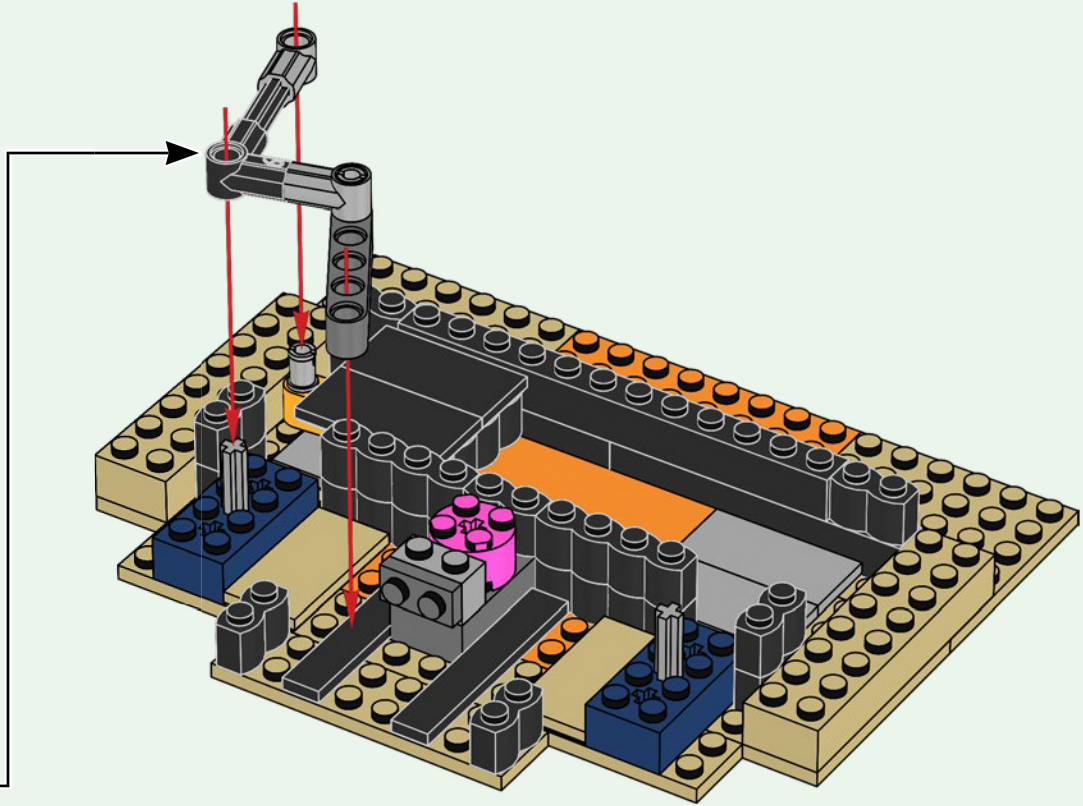



1x

26

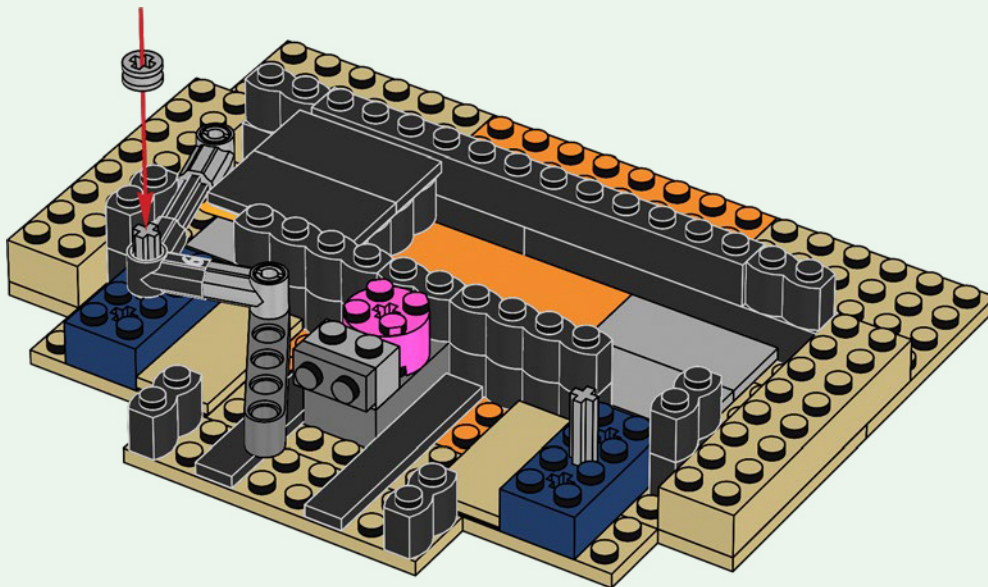



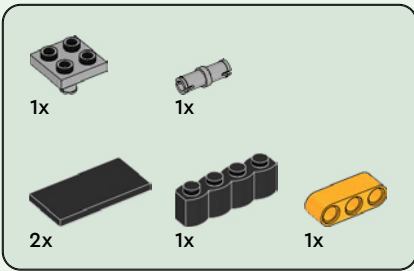

27

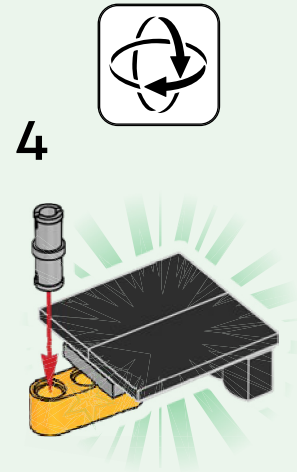
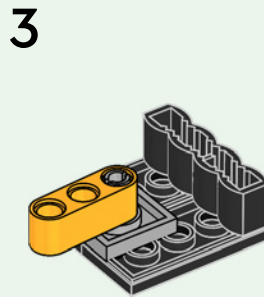
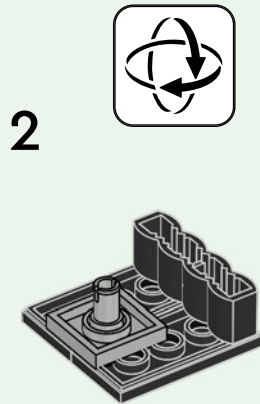
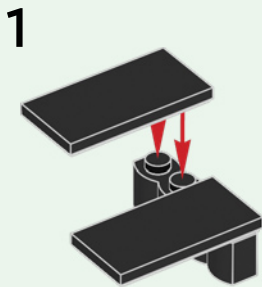

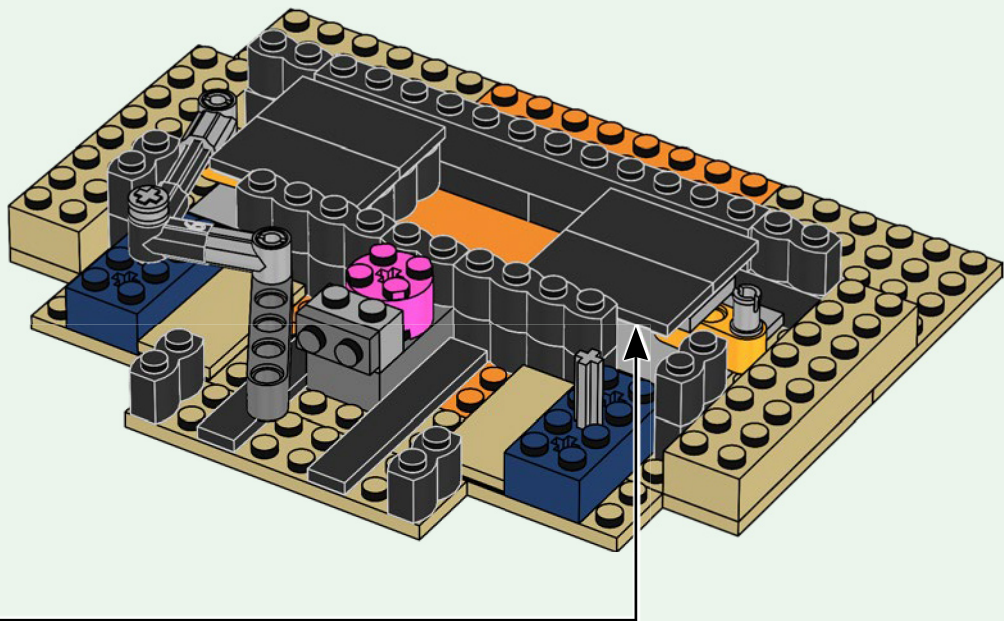

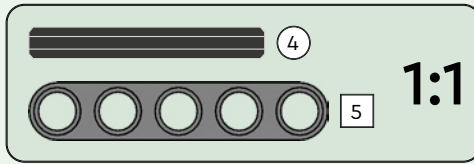
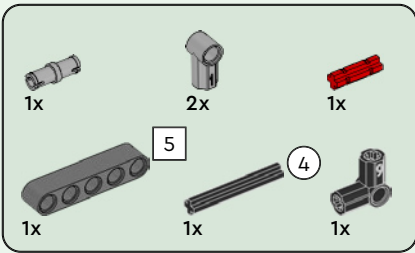

28

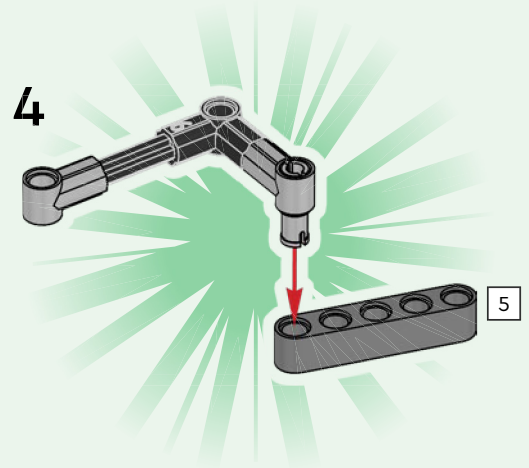
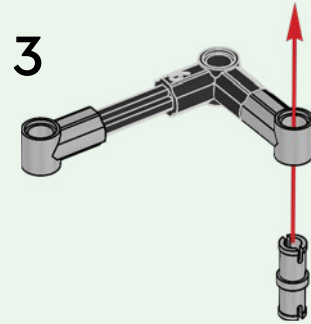
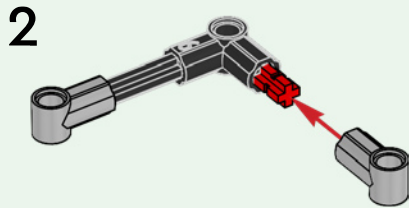

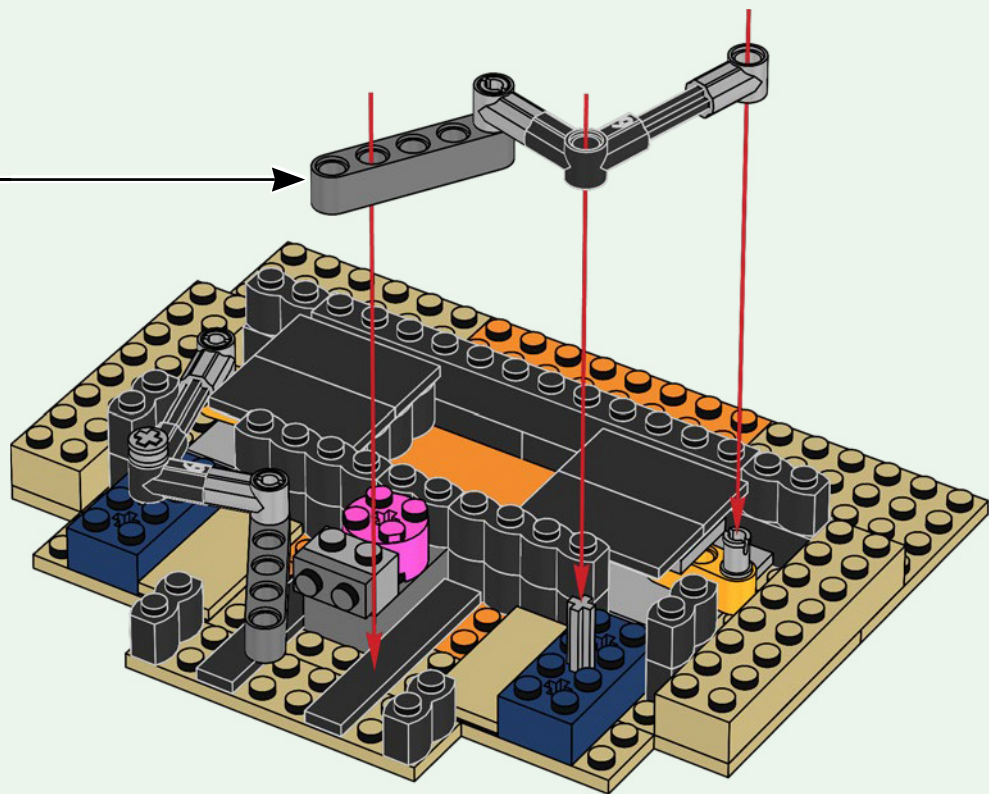



29

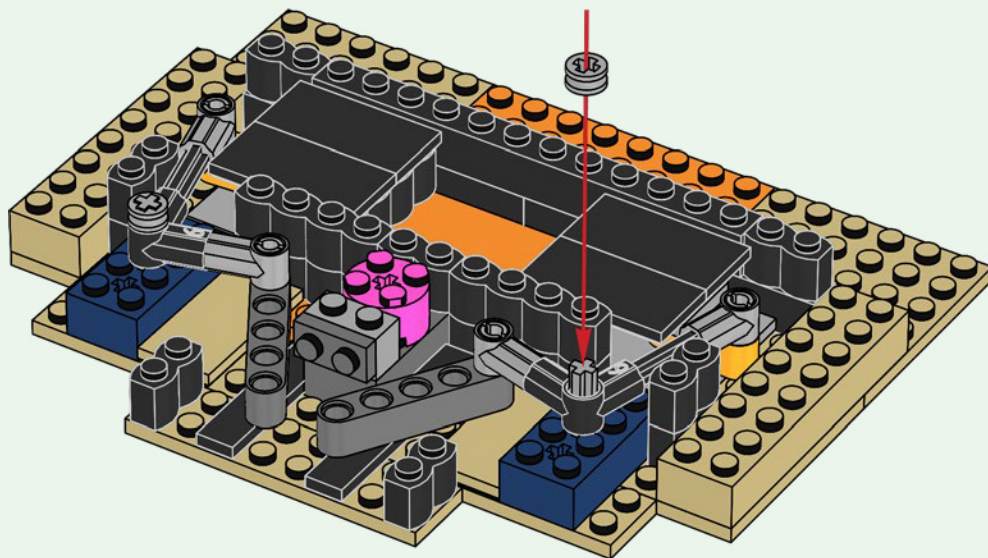

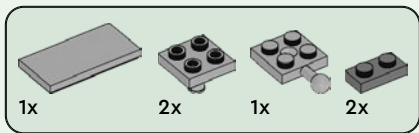

# 30

1

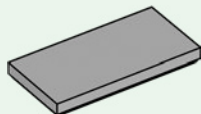

2

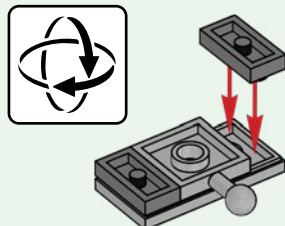

3

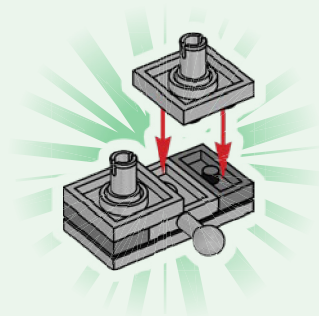

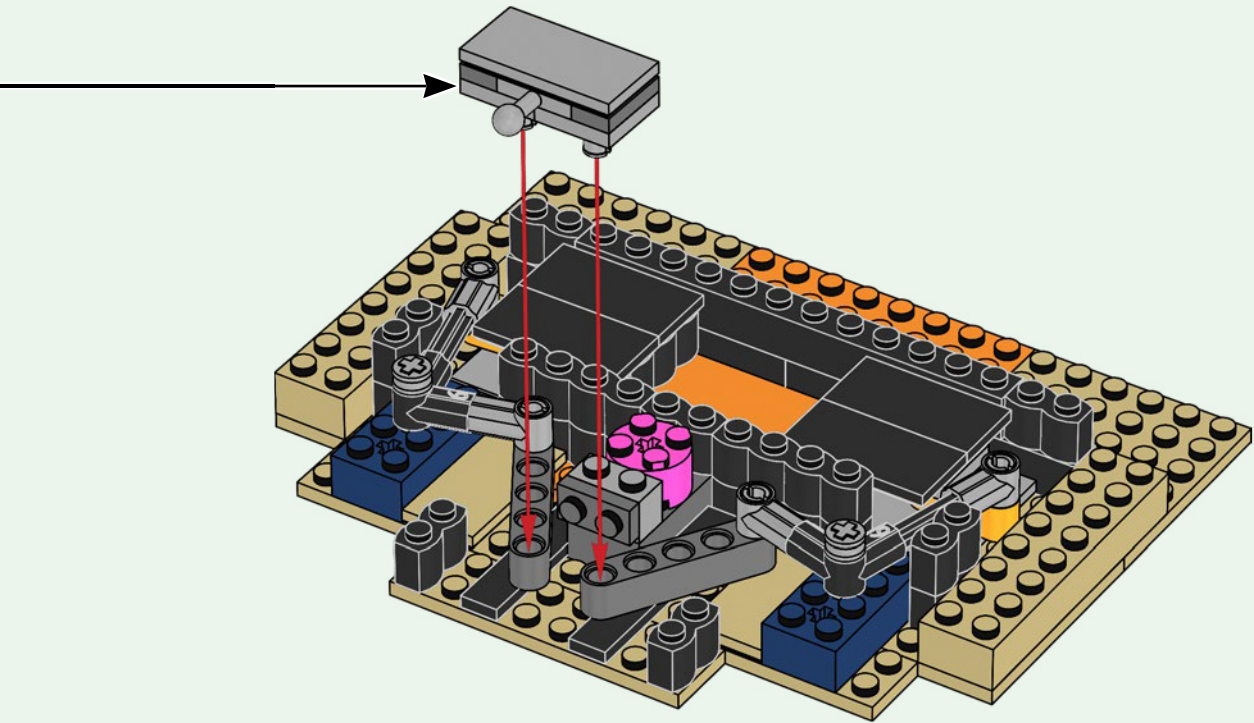



2x

31

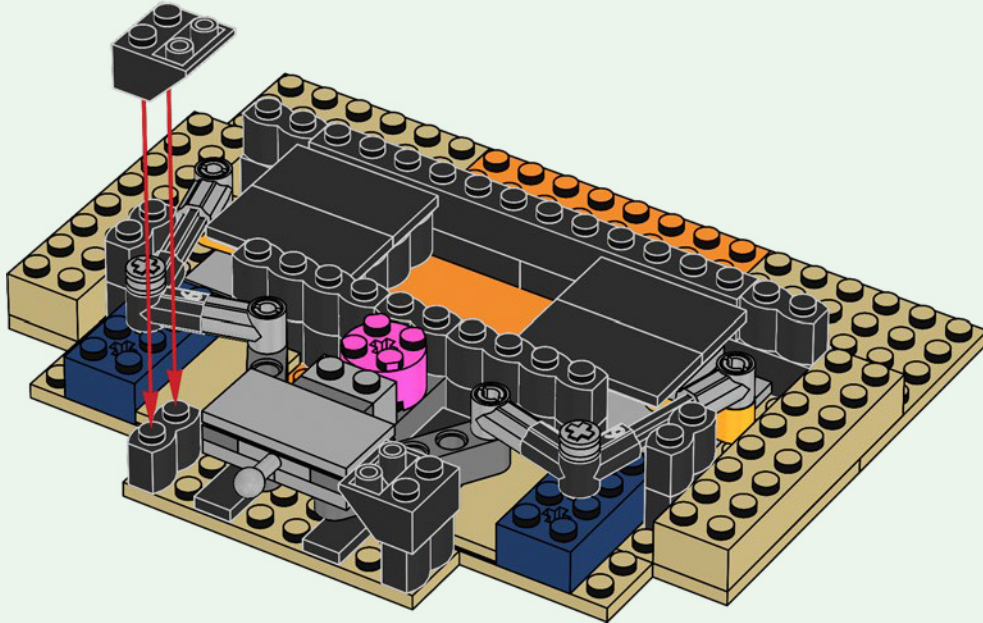



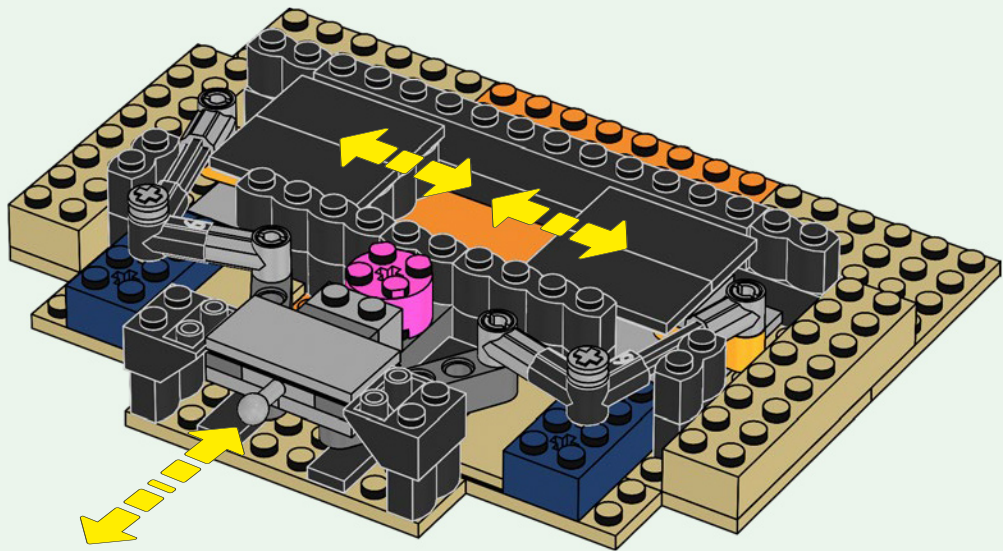

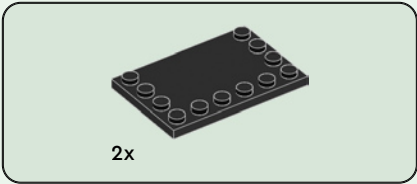

32

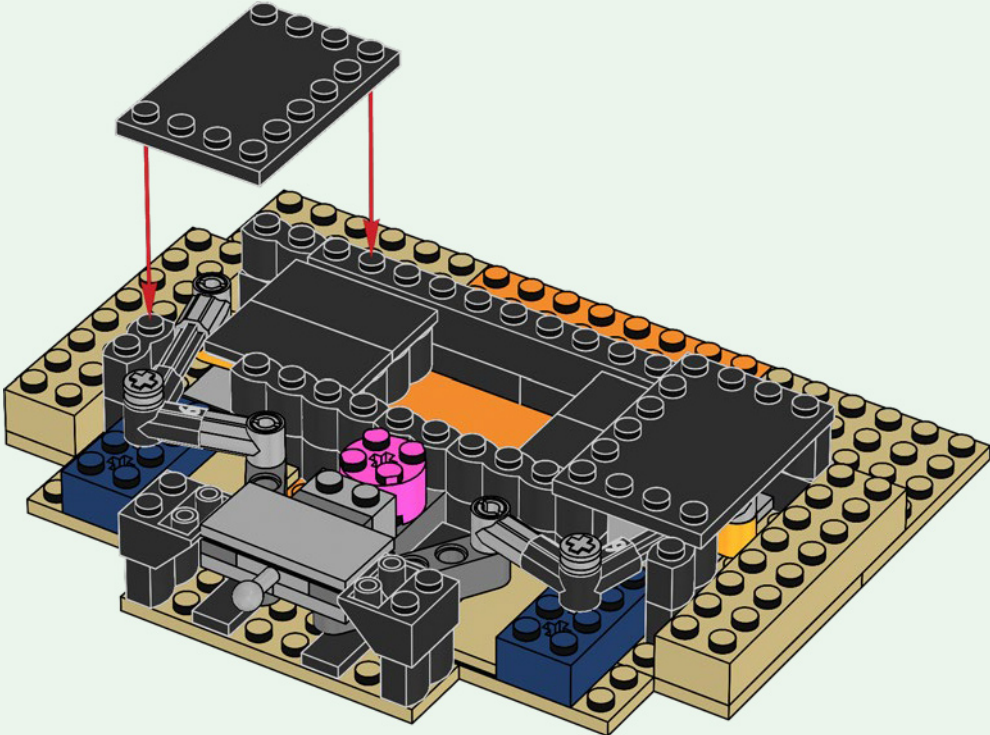

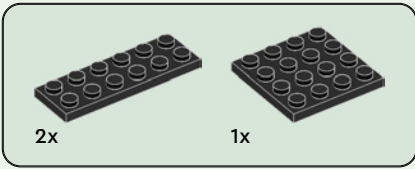

33

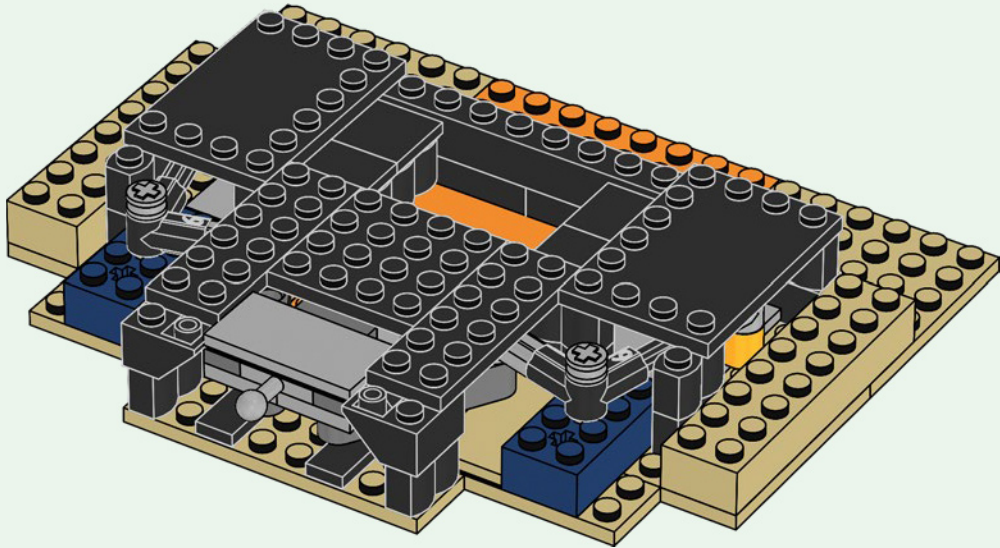



2x

# 34

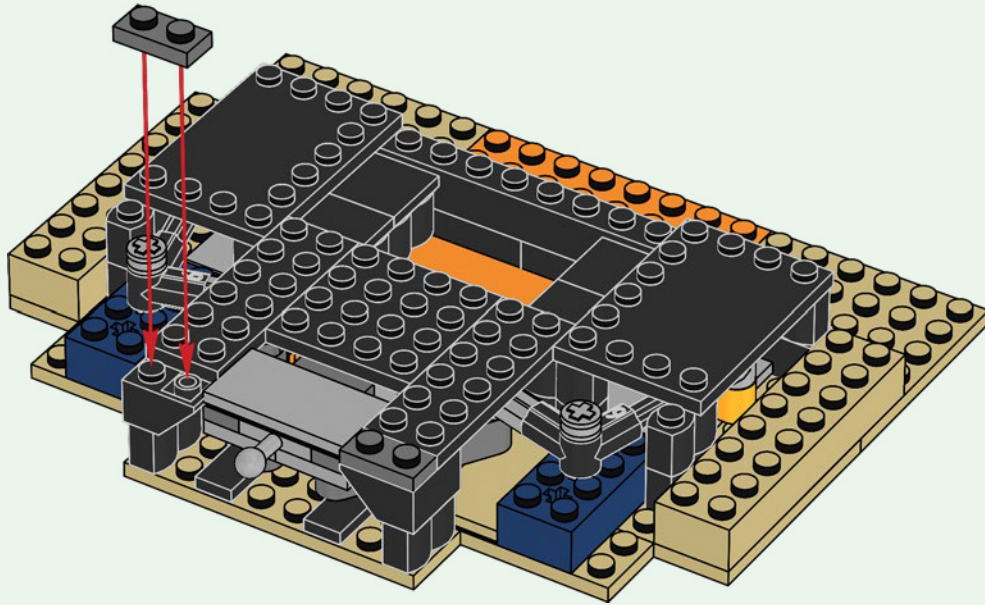



2x



2x

35

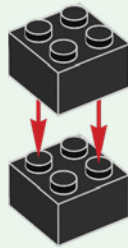



2x

36

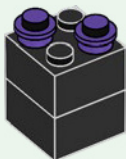

2x

37

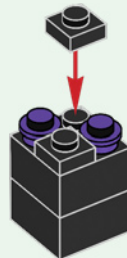



1x

38

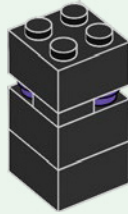

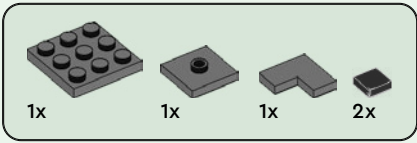

39

1

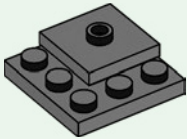

2

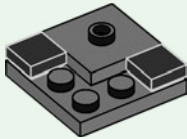

3

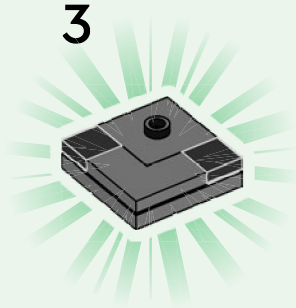





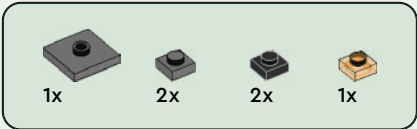

40

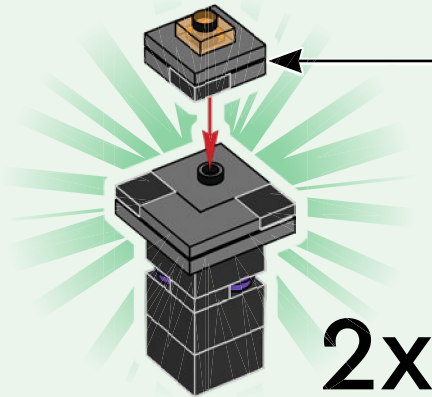
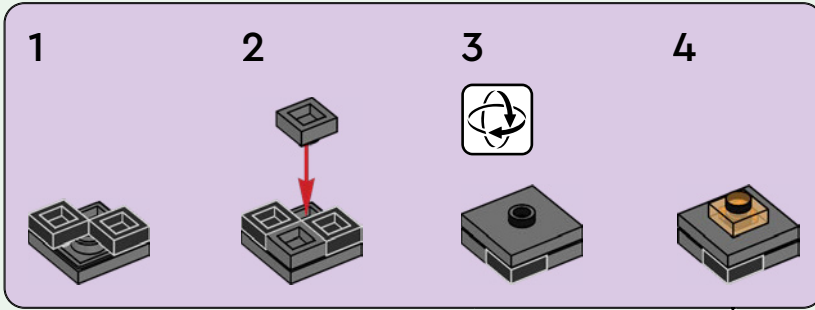

41

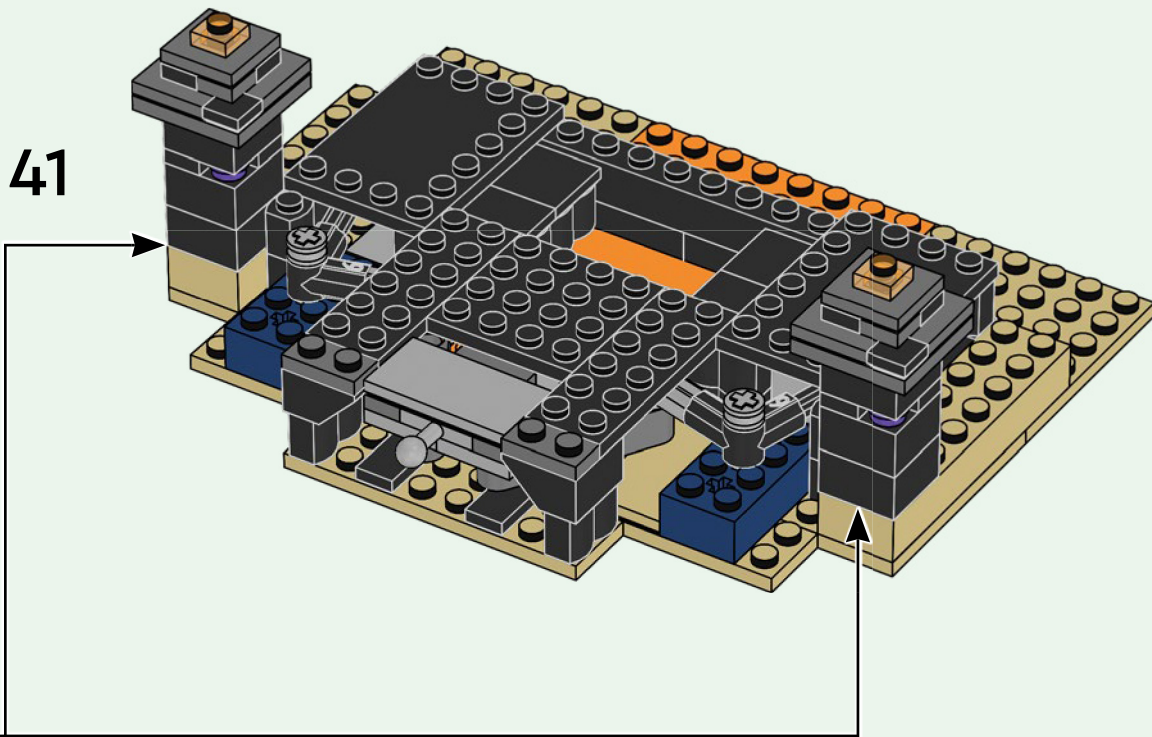

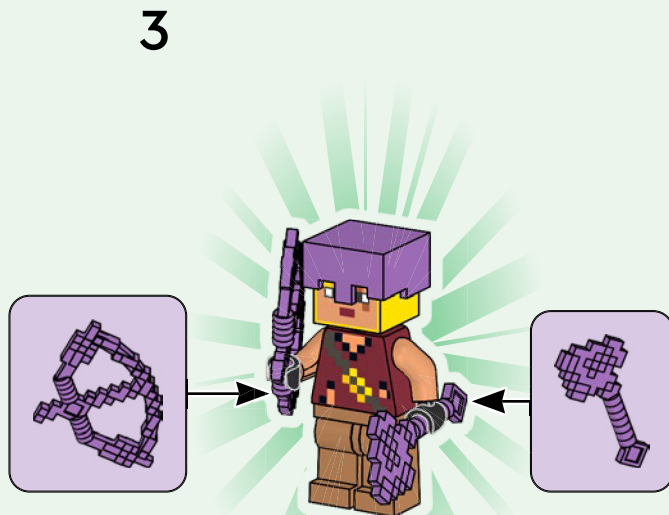

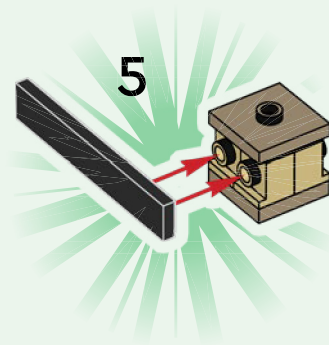
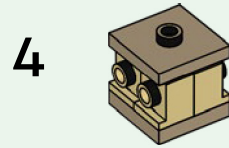
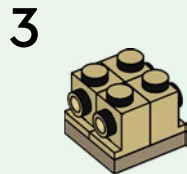
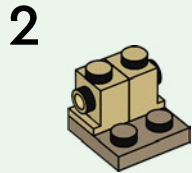
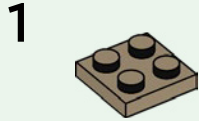
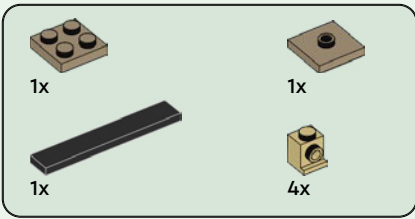

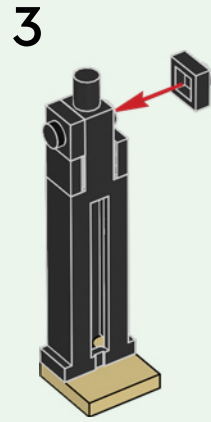
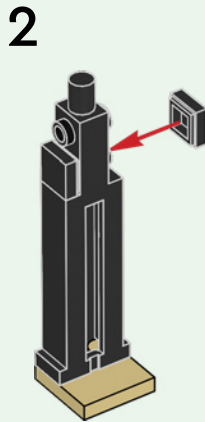
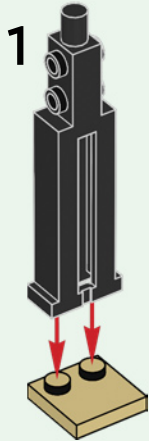
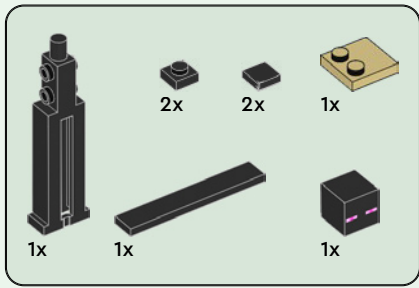

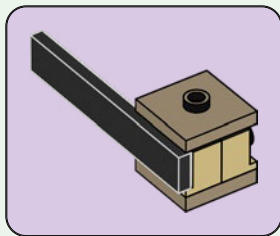

4

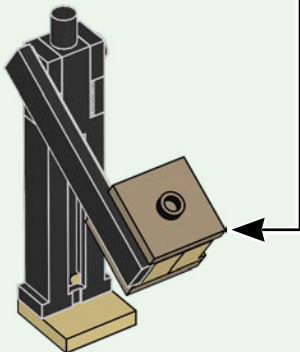

5

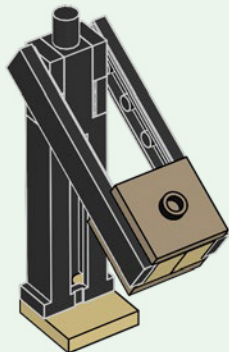

6

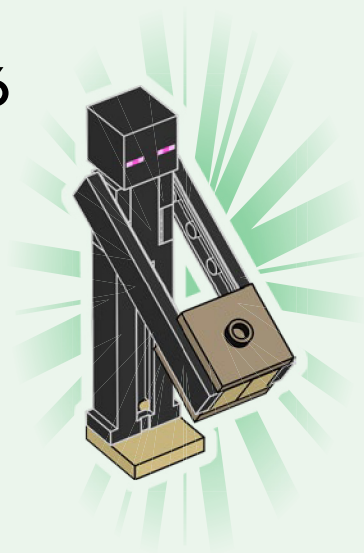

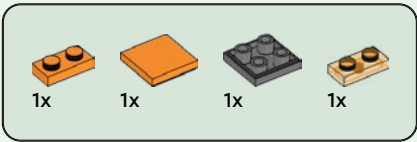
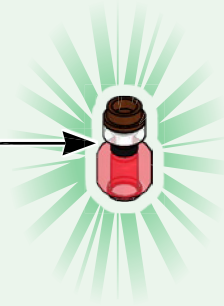
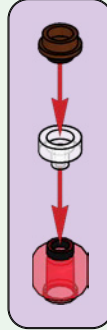
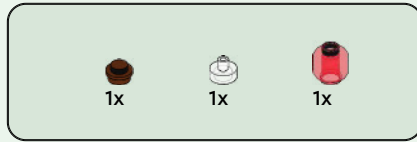
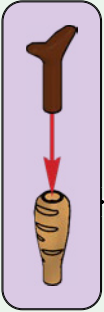
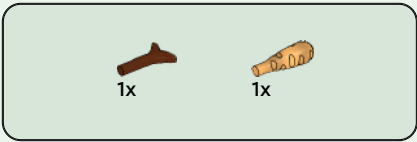

1

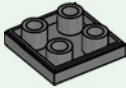

2

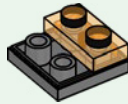

3



4





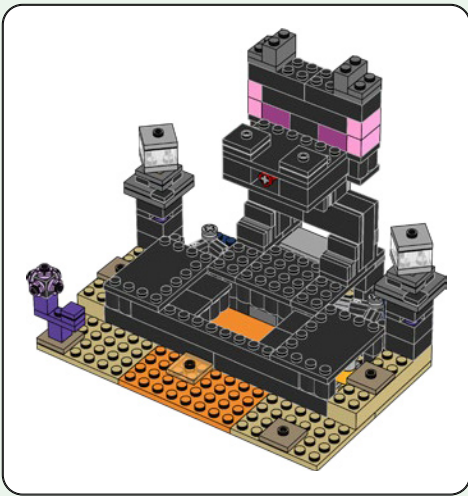

2x



2x



2x



2x

42

1

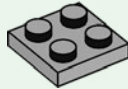

2

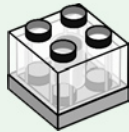

3



2x



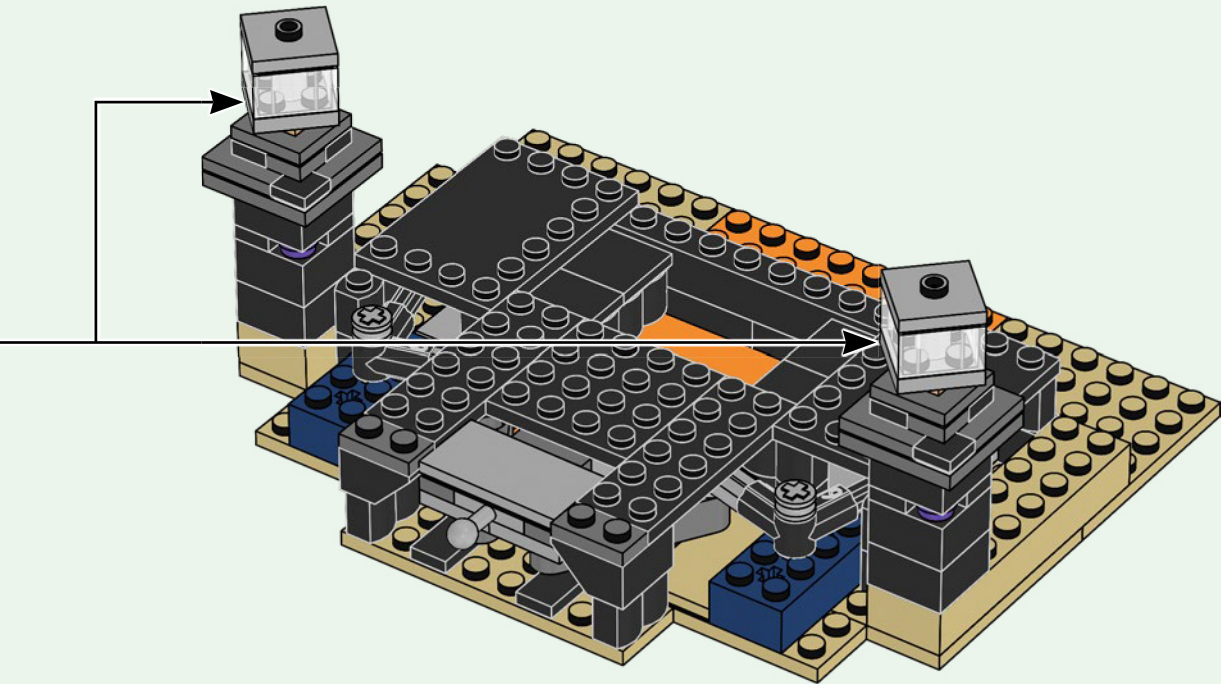

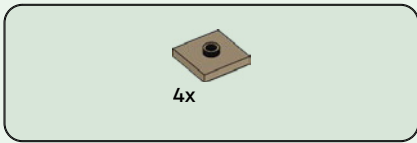

43

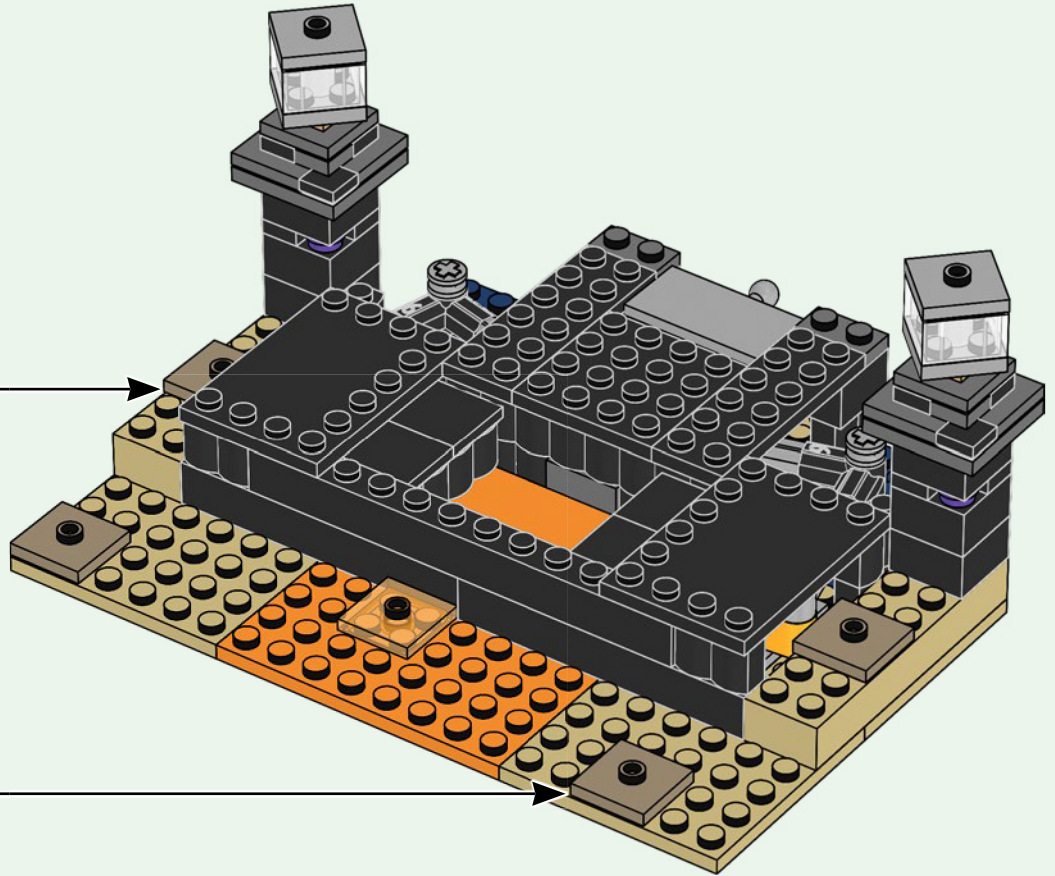
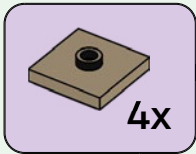

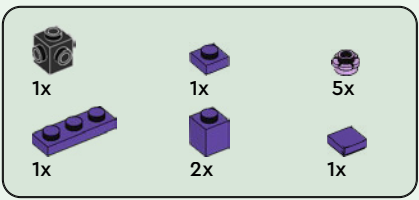

# 44

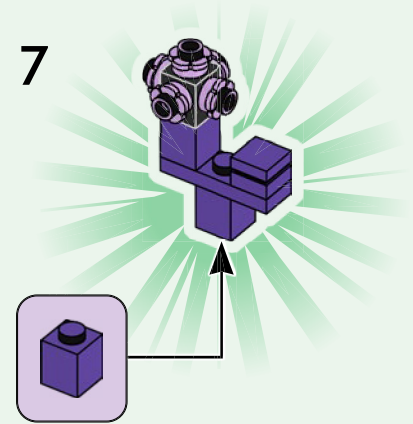
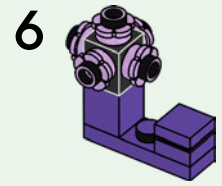
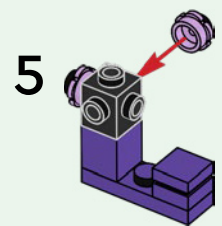
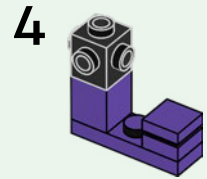
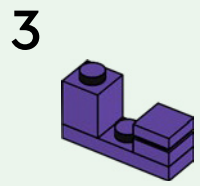
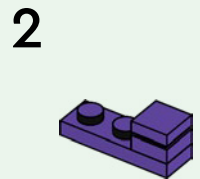
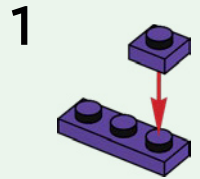

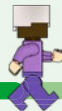
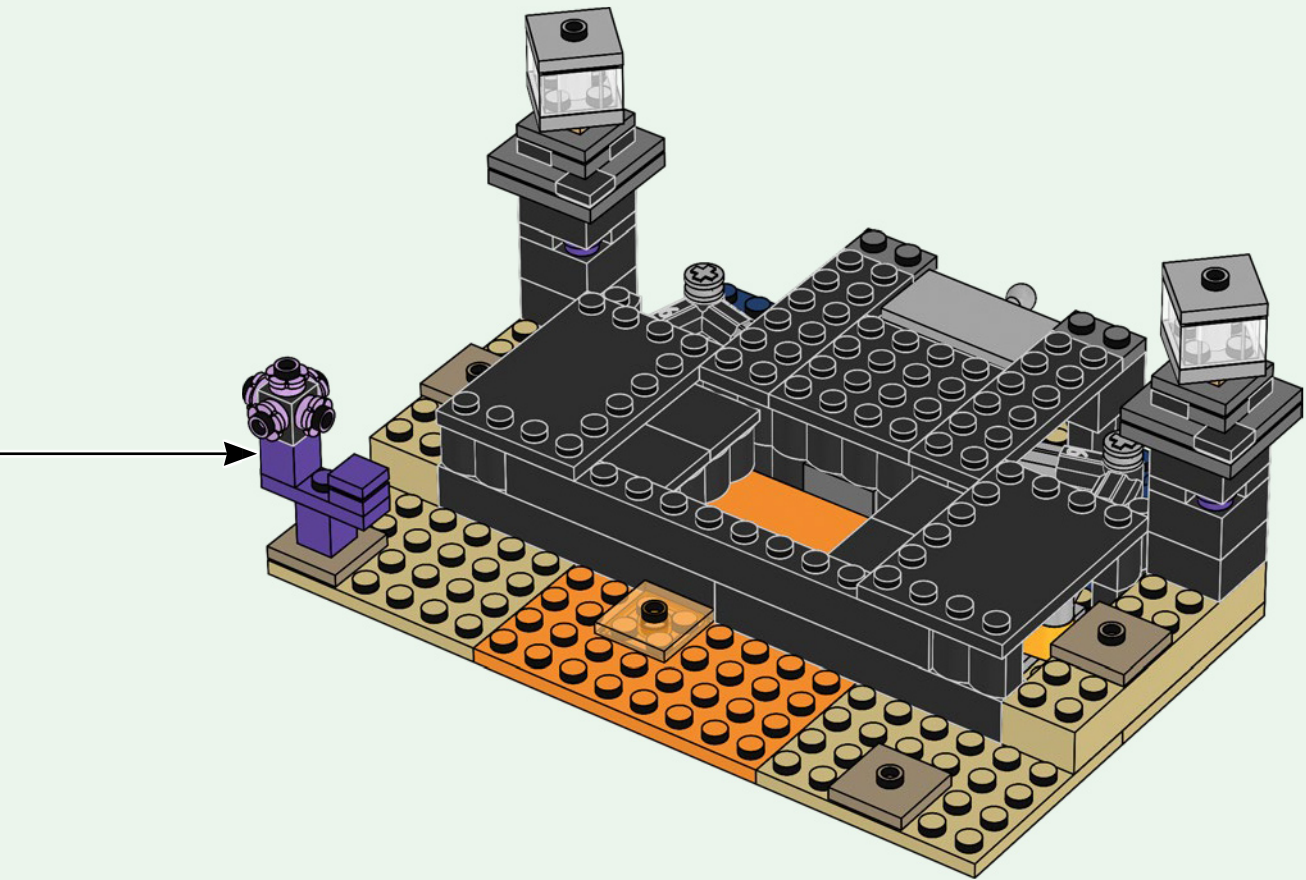

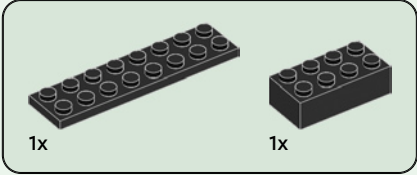
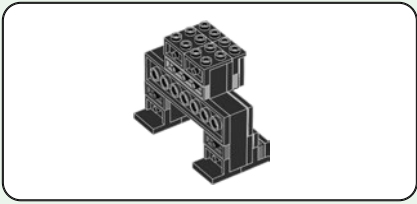

45

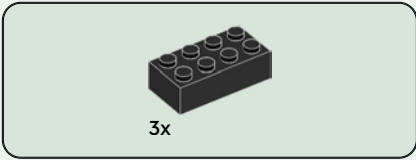
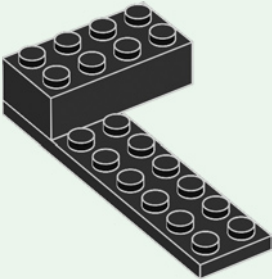

46

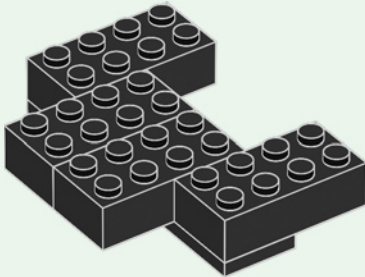

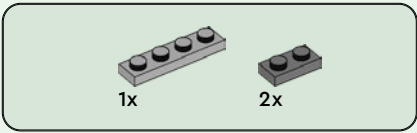

47

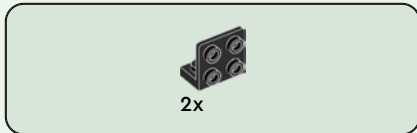
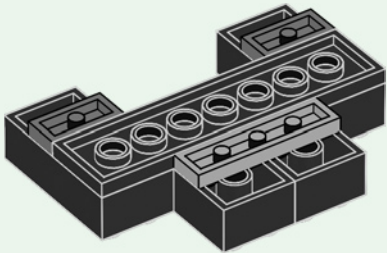

48

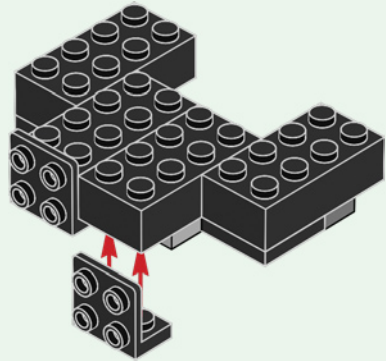

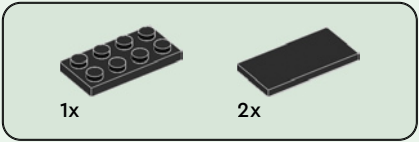

49

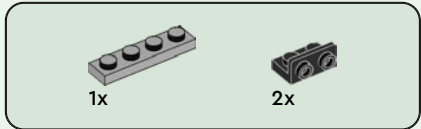
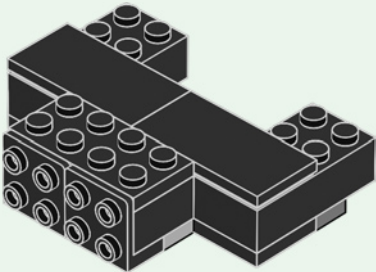

50

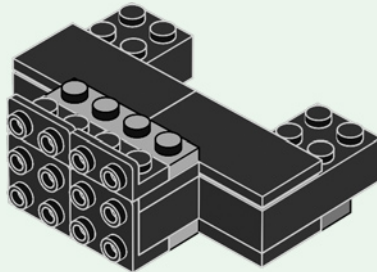



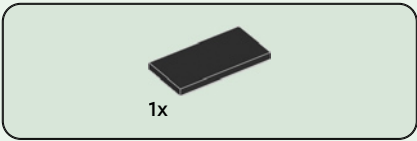

51

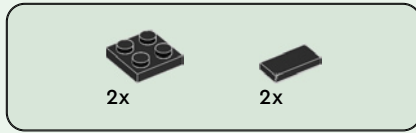
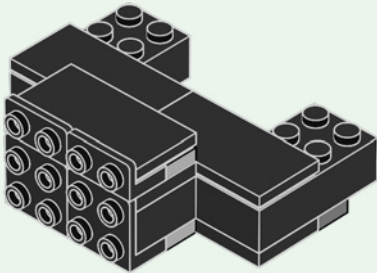

52

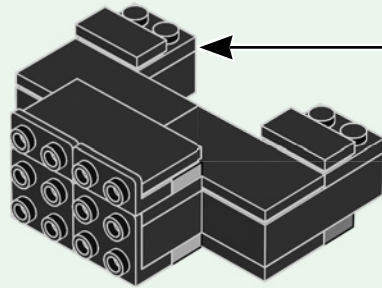
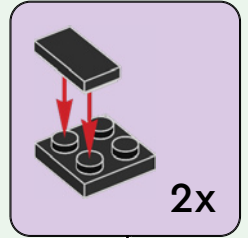

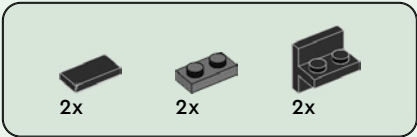

53

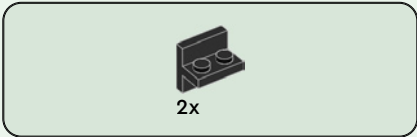
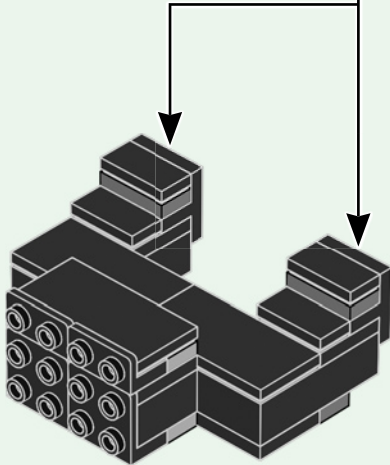
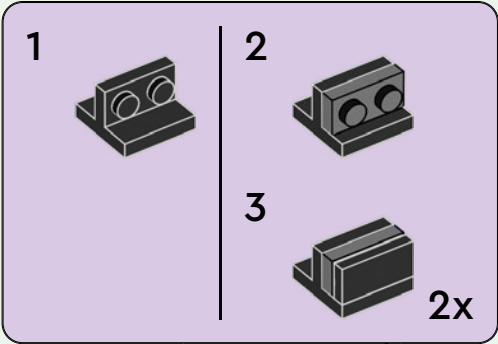

54

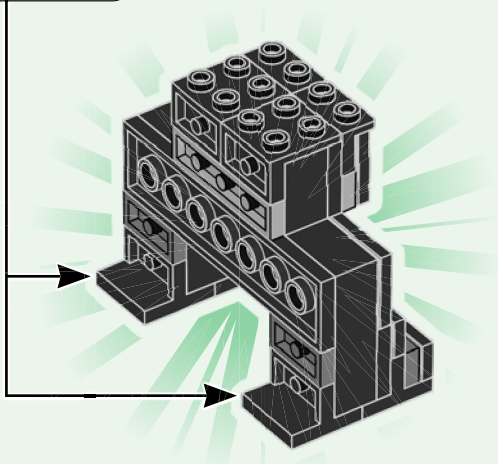
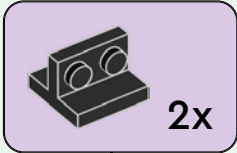

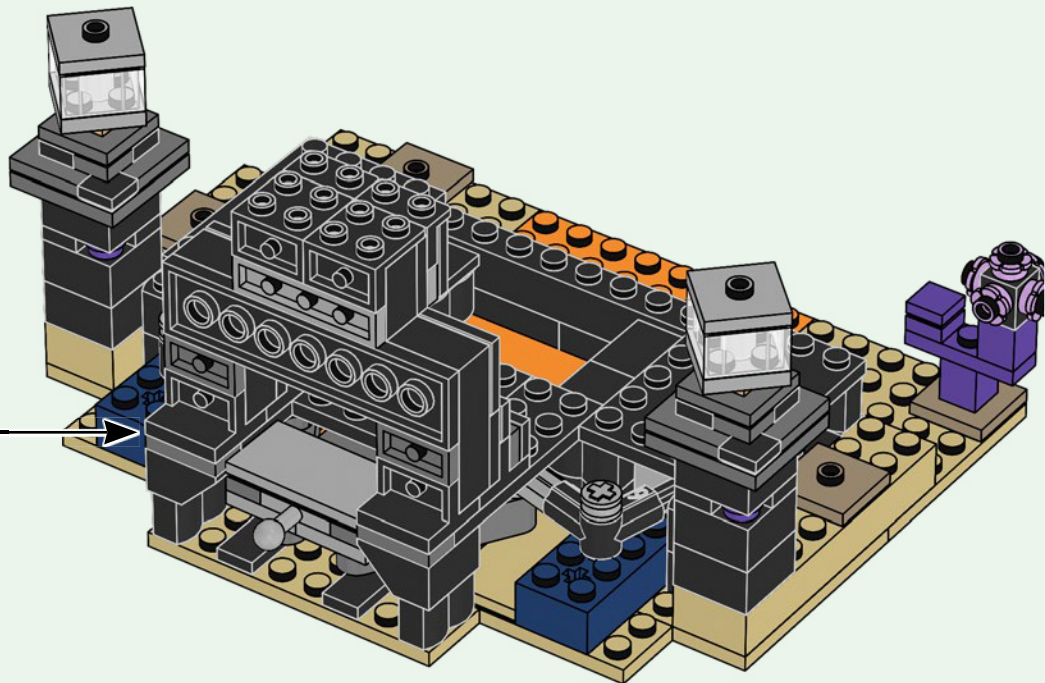

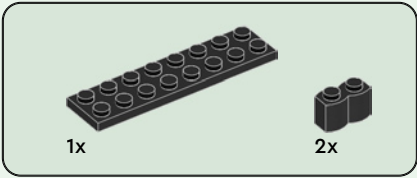
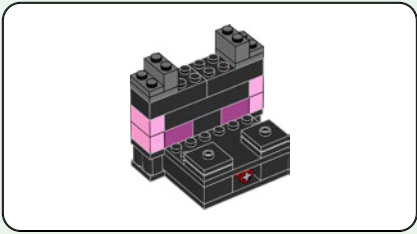

56

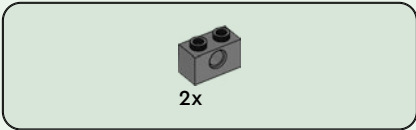
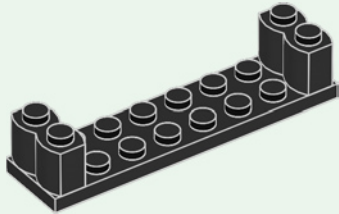

57

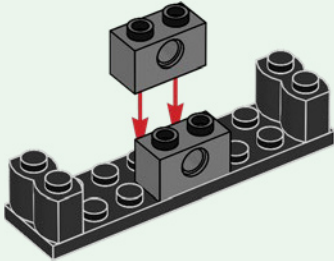

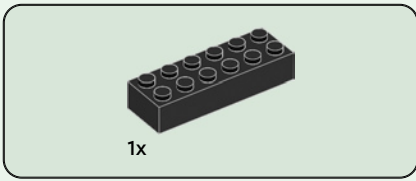

58

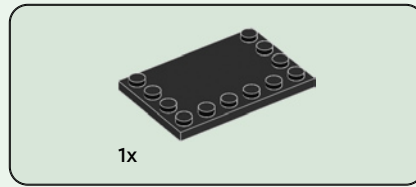
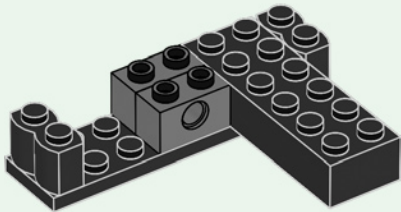

59

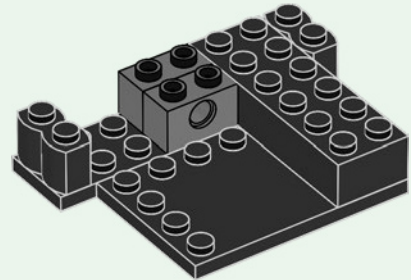

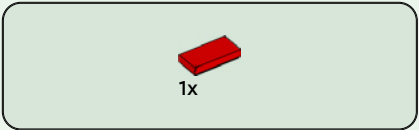

60

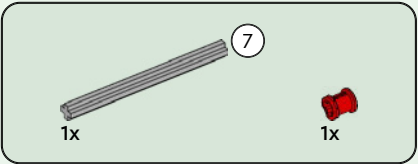
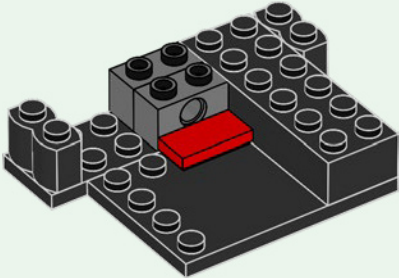

61

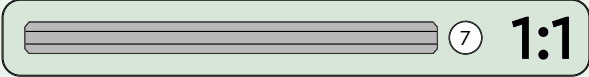
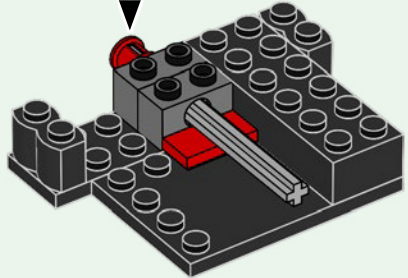
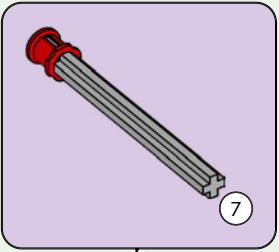



1x

62

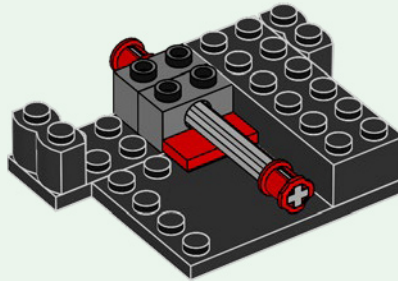

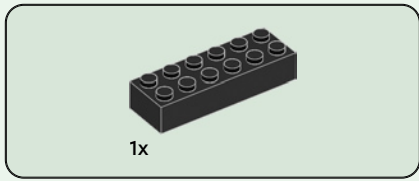

63

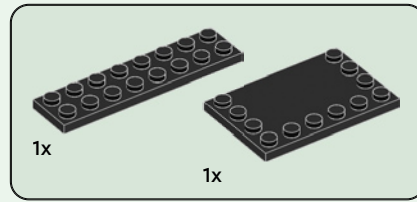
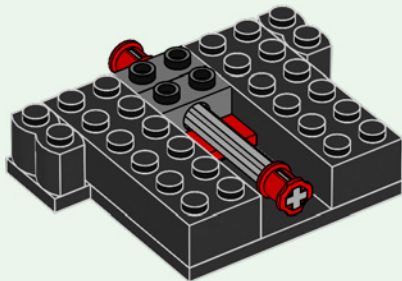

64

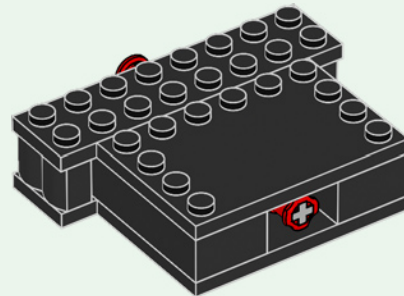



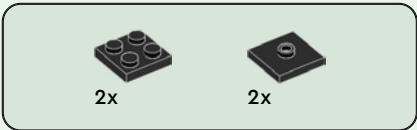

65

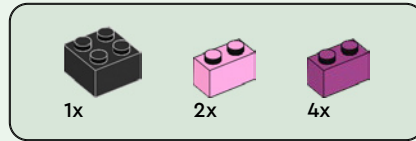
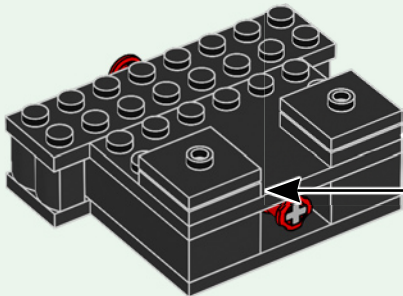
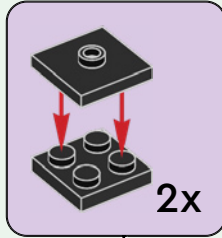

66

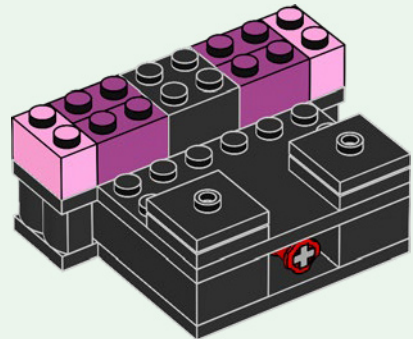

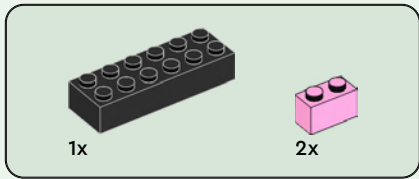

67

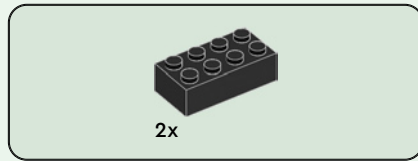
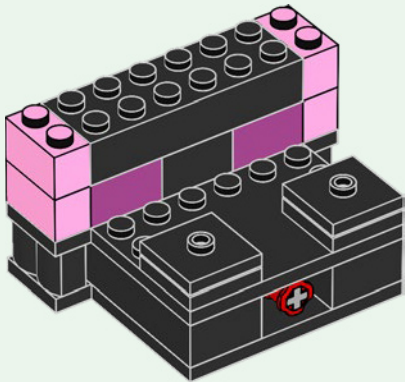

68

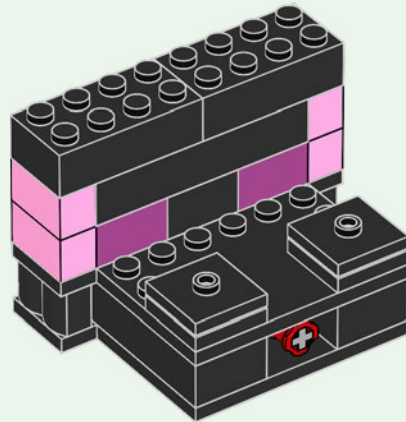



2x

69

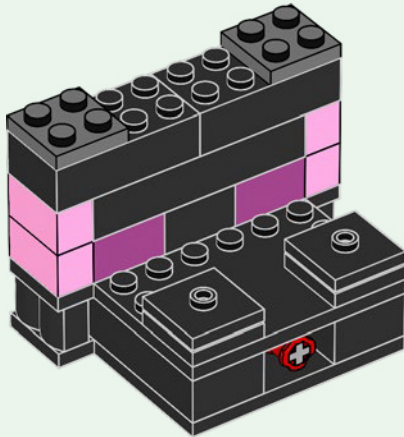

2x



2x

70

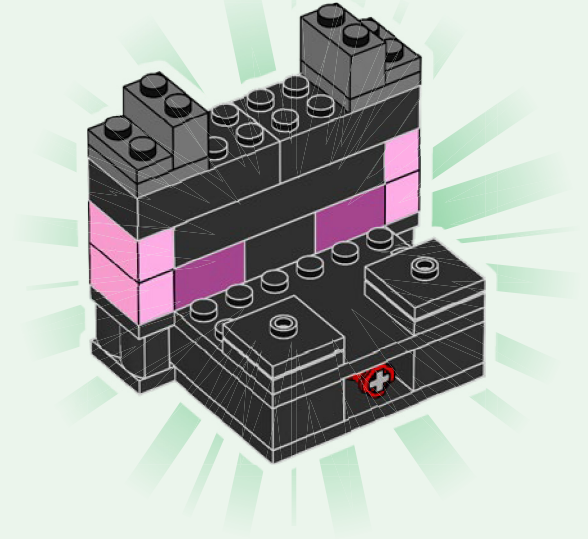

71

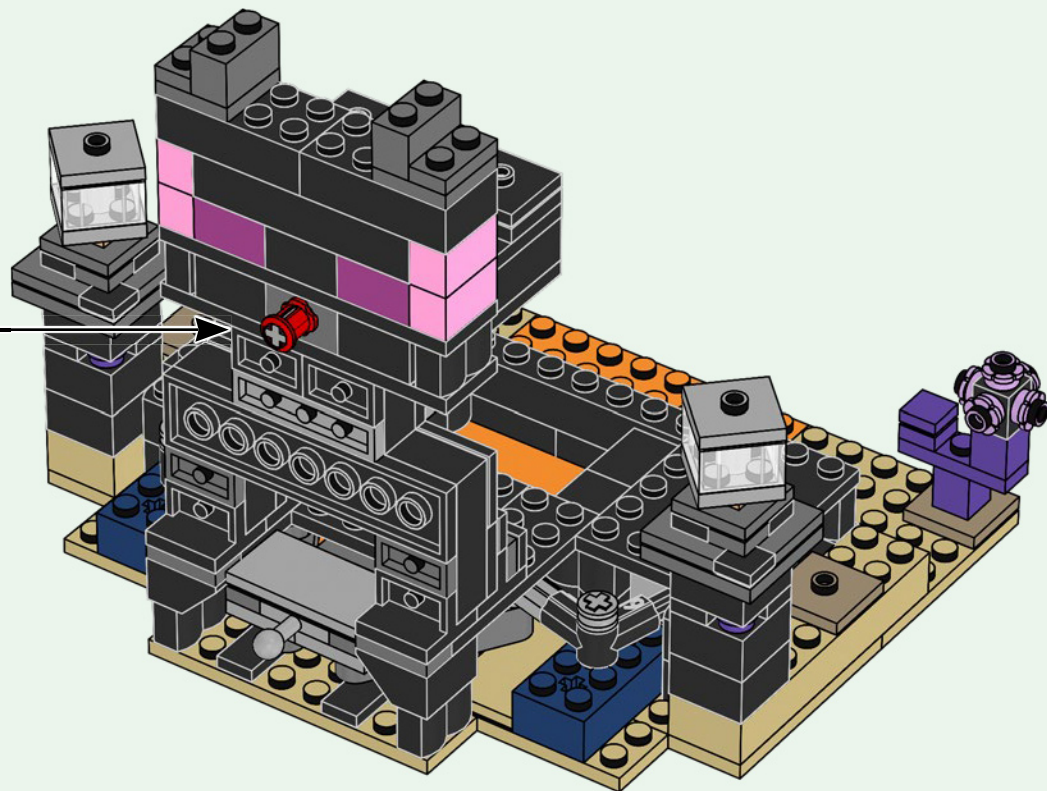

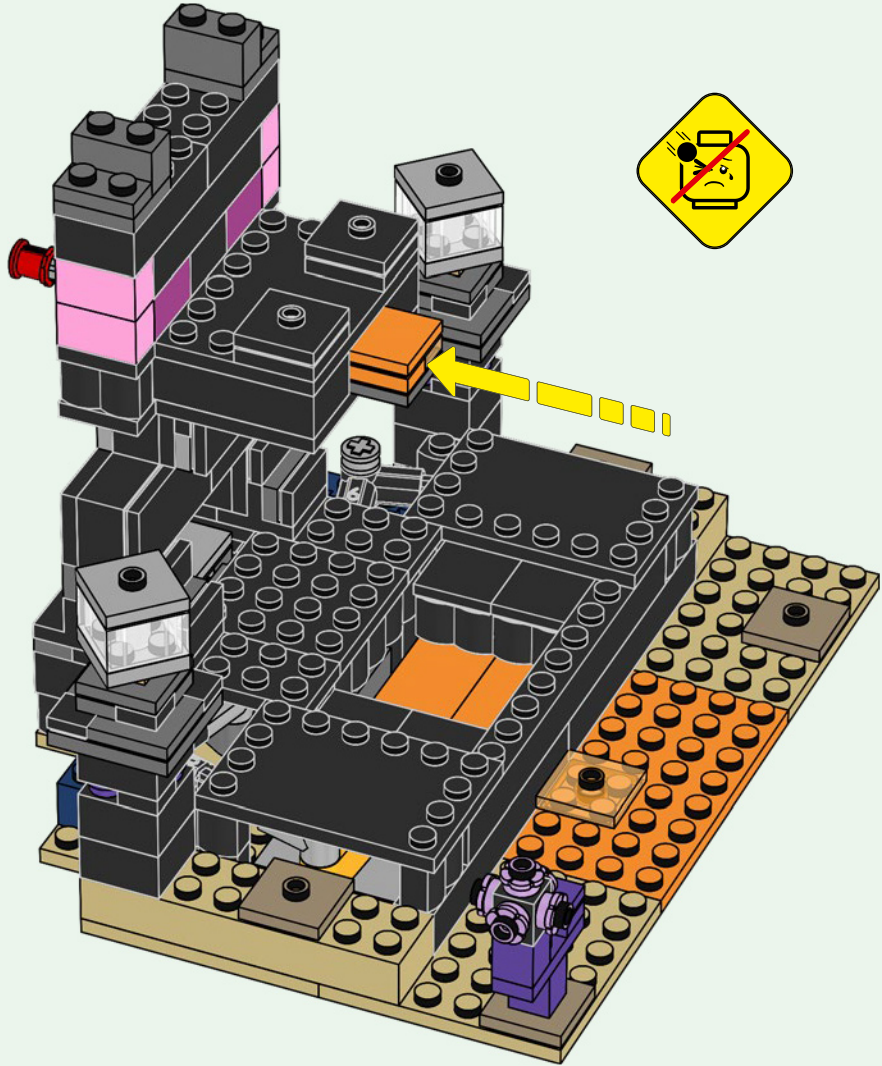

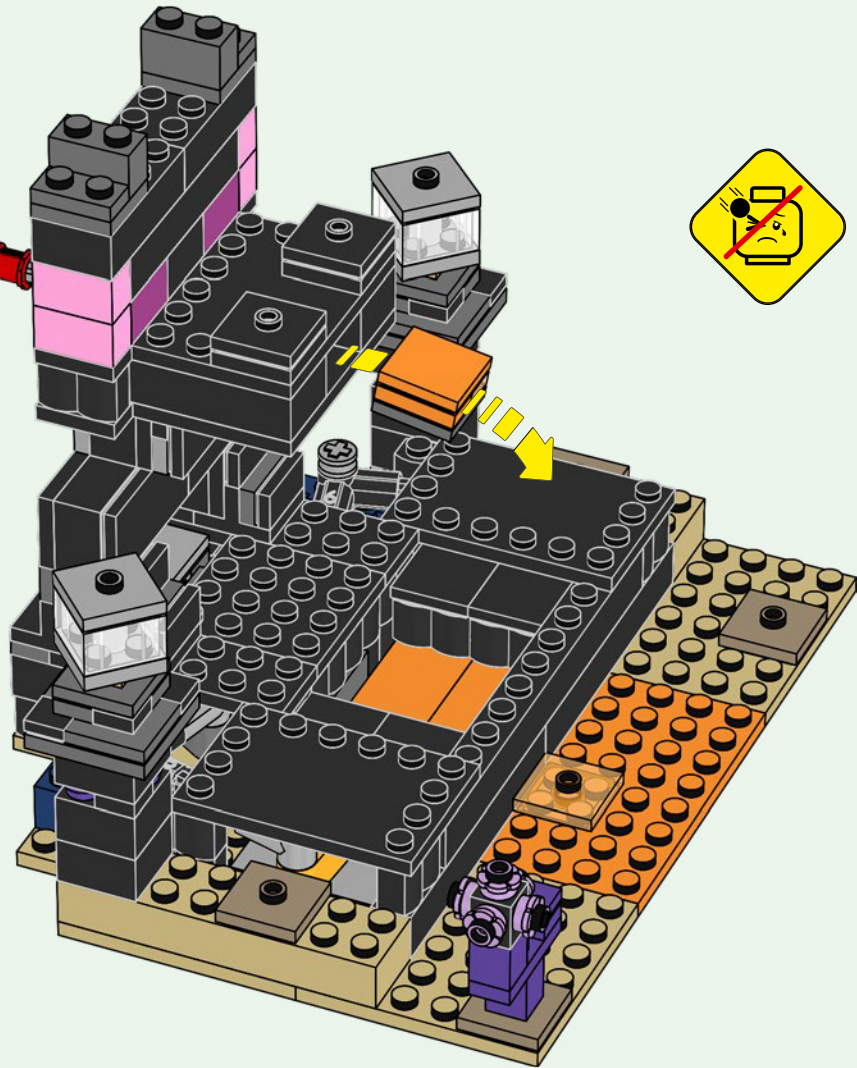
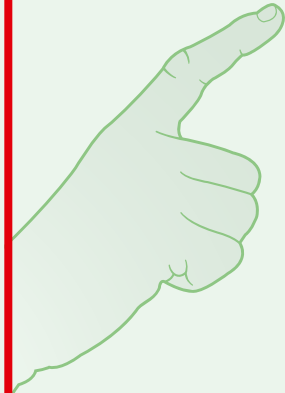





# MINECRAFT

21243



21244



21241



21245







# MINECRAFT

21242



21246





1x  
4125253



1x  
6422994



4x  
4118793



1x  
6221467



2x  
6122047

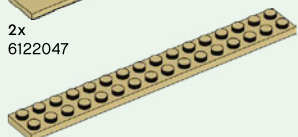

1x  
6030980

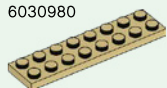

1x  
4113988

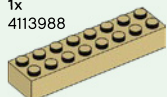

2x  
6037398



4x  
4125217



2x  
6271820



2x  
4142865



1x  
306921



1x  
6423958

82



1x  
6356406



10x  
302426



6x  
307026



1x  
473326



11x  
4644456



1x  
6162466



2x  
6268905



4x  
306926



1x  
6101874



2x  
6020193



2x  
6000650



4x  
6250020



7x  
300326



300326



2x  
6425507



4x  
302226



2x  
4565323



2x  
370526



6x  
6230228



7x  
4560182



6x  
300126



1x  
302026



4x  
663626



1x  
4243819



3x  
4181144



2x  
379526



2x  
379526



2x  
379526



2x  
379526

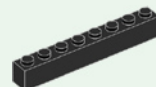

2x  
300826



4x  
4100378



3x  
303426



1x  
611226



1x  
6186867



2x  
6239418



1x  
6276023



1x  
4177932



1x  
4542142



2x  
6387565



2x  
6424454



2x  
6424454



4x  
4519195

4x  
4519195

4



5x  
6126075



1x  
6047415



2x  
6384912



1x  
6411849



2x  
6252040



1x  
6240217



1x  
6394956



2x  
6418455



1x  
4216581



1x  
6078605



2x  
6271165



4x  
6296859



4x  
4211807



1x  
6015344



4x  
6276848



2x  
4211397



2x  
6126082



2x  
4211815



1x  
6359225



1x  
6430844



2x  
4211445



5x  
4560183



1x  
4211805



4x  
4210719



11x  
4211063



2x  
4211088



2x  
4211111



1x  
6013082



2x  
4211094



4x  
6126083



2x  
6247784



2x  
6039176



1x  
4211085



2x  
4210686



1x  
6422439



4x  
4517993



4x  
4566522



2x  
6084028



1x  
6231376



1x  
6167457



1x  
4586410



1x  
6035470



1x  
6424453



1x  
6192830



1x  
6167567



1x  
6421063



1x  
6426335



1x  
6421062



1x  
6430920



5x  
6214235



1x  
6186837



1x  
6423956



1x  
6262262



1x  
6214216



1x  
6350506



 [LEGO.com/service](https://www.LEGO.com/service)

YOU COULD **WIN**



Scan this QR code or go to **LEGO.COM/PRODUCTFEEDBACK** and give us your short feedback about this LEGO® set for a chance to win a cool LEGO prize.

Terms and Conditions apply\*

**DE: Du könntest GEWINNEN.** Es gelten die Teilnahmebedingungen\* **FR: Tu pourrais GAGNER.** Des conditions s'appliquent\* **IT: Potresti VINCERE tu.** Termini e condizioni sono applicabili\* **ES: Puedes GANAR.** Aplican términos y condiciones\* **PT: Poderá GANHAR.** Aplicam-se termos e condições\* **JA: プレゼント付き! 利用規約が適用されます\*** **ZH: 轻松获奖. 条款和条件适用\*** **KO: 상품의 주인이 되어보세요. 소정의 약관이 적용됩니다\*** **RU: Вы можете ВЫИГРАТЬ.** Действуют положения и условия\* **PL: Szansa na WYGRANĄ.** Obowiązują warunki korzystania\* **CS: Máte šanci VYHRÁT.** Platí všeobecné smluvní podmínky\* **SK: Máte šancu VYHRAŤ.** Platia všeobecné zmluvné podmienky\* **HU: TE IS NYERHETSZ.** Felhasználási feltételek érvényesek\* **RO: Ai putea CÂȘTIGA.** Se aplică termeni și condiții\* **BG: Можете да СПЕЧЕЛИТЕ.** Има определени правила и условия\* **LV: Tu vari LAIMĒT.** Ir spēkā noteikumi un nosacījumi.\* **ET: Sul on võimalus VÕITA.** Kehtivad tingimused\* **LT: Jūs galite LAIMĖTI.** Taikomos sąlygos\*

\*[LEGO.com/productfeedback-terms](https://www.lego.com/productfeedback-terms)

LEGO and the LEGO logo are trademarks of the/sont des marques de commerce du/son marcas registradas de LEGO Group. ©2023 The LEGO Group.



© 2023 Mojang AB. All Rights Reserved. Minecraft, the Minecraft logo, the Mojang Studios logo and the Creeper logo are trademarks of the Microsoft group of companies.